

JVC

COLOUR TELEVISION

AV32P10EK / AV32P10EI / AV32L5EK / AV32L5EI

COLOUR TELEVISION

AV32P10EK AV32L5EK

(UK model)

AV32P10EI AV32L5EI

(Ireland model)

InteriArt
Natural Vision
T-V LINK

INSTRUCTIONS

Specifications

Item	Model	AV32L5EK* (UK model)	AV32L5EI* (Ireland model)
Broadcasting systems		CCIR I	
Colour systems		PAL • The EXT terminals also support the NTSC 3.58/4.43 MHz system.	
Channels and frequencies		E21-E69	IR A-J, E2-E12, E21-E69, S1-S41, X, Y, Z, Z+1, Z+2, ITALY A-H, ITALY H+1, ITALY H+2
Sound-multiplex systems		NICAM (I) system	
Teletext systems		FLOF (Fastext), WST (World Standard Text)	
Power requirements		220 - 240 V AC, 50 Hz	
Power consumption		Maximum: 189 W, Average: 140 W, Standby: 2.8 W	
Picture tube size		Viewable area 76 cm (measured diagonally)	
Audio output		Rated Power output: 7.5 W + 7.5 W	
Speakers		(20 cm x 4 cm) oval x 2	
EXT-1 terminal		Euroconnector (21-pin, SCART) • Video input, Audio L/R inputs and RGB inputs are available. • TV broadcast outputs (Video and Audio L/R) are available.	
EXT-2 terminal		Euroconnector (21-pin, SCART) • Video input, S-VIDEO (Y/C) input, Audio L/R inputs and RGB inputs are available. • Video and Audio L/R outputs are available. • T-V LINK functions are available.	
EXT-3 terminal		Euroconnector (21-pin, SCART) • Video input, S-VIDEO (Y/C) input and Audio L/R inputs are available.	
EXT-4 terminal		RCA connectors x 3 S-VIDEO connector x 1 • Video input, S-VIDEO (Y/C) input and Audio L/R inputs are available.	
AUDIO OUT terminal		RCA connectors x 2 • Variable audio L/R outputs are available. • Variable out 0-1 Vrms, low impedance	
Headphone jack		Stereo mini-jack (3.5 mm in diameter)	
Dimensions (W x H x D)		901 mm x 556 mm x 557mm	
Weight		53.9 kg	
Accessories		Remote control unit x 1 (RM-C56) AAA/R03 dry cell battery x 2	

* A basic model number. The actual model number may have characters added (such as "S" denoting silver) indicating the colour of the TV set.

We may change the design and specifications without notice.

Pictures displayed on the screen using this TV's ZOOM functions should not be shown for any commercial or demonstration purpose in public places (cafes, hotels, etc.) without the consent of the owners of copyright of the original picture sources, as this would be an infringement of copyright.

Contents

Safety precautions	2
Setting up your TV	4
T-V LINK functions	7
Using your TV—the basics	8
Remote control buttons and functions	11
Using the TV's menus	17
Picture setting	18
Picture features	19
Sound setting	21
DIGITAL SURROUND (Only AV32P10EK and AV32P10EI)	23
EXT SETTING	26
FEATURES	28
INSTALL	30
DEMO	34
Other menus	35
Further preparation	37
TV buttons and parts	41
Troubleshooting	42
Specifications	43

JVC

VICTOR COMPANY OF JAPAN, LIMITED

plain English
approved
by the word centre

Thank you for buying this **JVC** colour television.

To make sure you fully understand how to use your new TV, please read this manual thoroughly before you begin.

Safety precautions

■ Warning

To prevent fire or shock hazard, do not expose this appliance to rain or moisture.

■ Caution

To ensure personal safety, observe the following rules regarding the use of this unit.

- 1 Operate only from the power source specified (AC 220 – 240 V, 50 Hz) on the unit.
- 2 Avoid damaging the mains plug and power cord.
- 3 Avoid improper installation and never position the unit where good ventilation is unattainable. When installing this television, distance recommendations must be maintained between the floor and wall, as well as installation in a tightly enclosed area or piece of furniture. Please adhere to the minimum distance guidelines shown for safe operation.

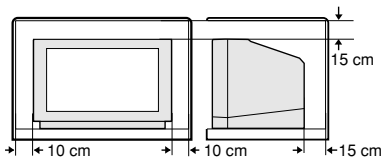

- 4 Do not allow objects or liquid into the cabinet openings.
- 5 In the event of a fault, unplug the TV and call a service technician. Do not attempt to repair it yourself or remove the rear cover.
- 6 The surface of the TV screen is easily damaged. Be very careful with it when handling the TV. Should the TV screen become soiled, wipe it with a soft dry cloth. Never rub it forcefully. Never use any cleaner or detergent on it.
- 7 The main power button on the TV does not fully isolate the TV from the mains supply. If you are not going to use this TV for a long period of time, be sure to disconnect the mains plug from the mains outlet.

■ Warning

DO NOT cut off the mains plug from this equipment. If the plug fitted is not suitable for the power points in your home or the cable is too short to reach a power point, then obtain an appropriate safety approved extension lead or adaptor or consult your dealer.

If nonetheless the mains plug is cut off, remove the fuse and dispose of the plug immediately, to avoid a possible shock hazard by inadvertent connection to the mains supply.

If a new mains plug has to be fitted, then follow the instruction given below:

Important

Do not make any connection to the larger terminal which is marked with the letter E or by the safety earth symbol \perp or coloured green or green-and-yellow.

The wires in the mains lead on this product are coloured in accordance with the following code:
Blue: Neutral
Brown: Live

As these colours may not correspond with the coloured marking identifying the terminals in your plug proceed as follows:

The wire which is coloured blue must be connected to the terminal which is marked with the letter N or coloured black.

The wire which is coloured brown must be connected to the terminal which is marked with the letter L or coloured red.

When replacing the fuse only a correctly rated approved type should be used and be sure to re-fit the fuse cover.

If in doubt — consult a competent electrician.

How to replace the fuse

Open the fuse compartment with a blade screwdriver, and replace the fuse.

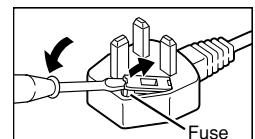

■ Guidelines for safe operation

This equipment has been designed and manufactured to comply with international safety standards. However, as with any electrical appliance, care must be taken to ensure optimal results and operational safety.

- Before attempting to use this equipment, read the operating instructions thoroughly.
- Ensure that all electrical connections (including the mains plug, extension leads, etc.) have been made in accordance with the manufacturer's instructions.
- If ever in doubt about the installation, operation or safety of this equipment, consult your dealer.
- Handle all glass panels or covers with care.
- Never operate this equipment if it appears damaged or operates abnormally. Turn the power off, disconnect the main power plug and consult your dealer.
- Never remove any affixed panels or covers. Doing so may result in electrical shock.
- Never leave this equipment operating unattended unless otherwise specifically stated that it is designed to do so or in standby mode. Only use the designated power switch to turn off the power and ensure that all potential users are instructed how to do so. Make special arrangements for infirm or handicapped persons.
- Never listen to headphones at high volume. Doing so may damage your hearing.
- Never obstruct the ventilation of this equipment. Doing so may cause overheating and result in a malfunction or damage.
- Never use makeshift stands or attempt to affix legs with wood screws. When using a manufacturer's approved stand or legs, use only the fixtures provided and follow the installation instructions.
- Never allow this equipment to be exposed to rain or moisture.
- Never allow anyone, especially children, to insert anything into an opening in the case. Doing so may result in a fatal electrical shock.
- Never guess or take chances with electrical equipment of any kind. It is better to be safe than sorry.

Setting up your TV

■ Connecting the aerial and video cassette recorder (VCR)

If you are connecting a VCR, follow (A) → (B) → (C) in the diagram opposite.

If you are not connecting a VCR, follow ①.

- For more details, see the manuals that came with the equipment you want to connect.
- The connecting cables are not provided.
- You can watch a video using the VCR without doing (C). For details, see your VCR instruction manual.
- To connect more equipment, please see "Further preparation" on page 37.
- To connect additional audio equipment, see "Using additional audio equipment" on page 39.
- To connect other equipment (such as a DVD player) with a digital output terminal for Dolby Digital, see "Listening to Dolby Digital audio (Only AV32P10EK and AV32P10EI)" on page 38.
- If you connect a decoder to a T-V LINK compatible VCR, set the DECODER (EXT-2) function to ON. For details, see "Using the DECODER (EXT-2) function" on page 35. Otherwise, you will not be able to watch scrambled channels.

To use the T-V LINK functions, you must have a T-V LINK compatible VCR connected by a SCART cable (C) to the EXT-2 terminal on the TV. For details about T-V LINK functions, see "T-V LINK functions" on page 7.

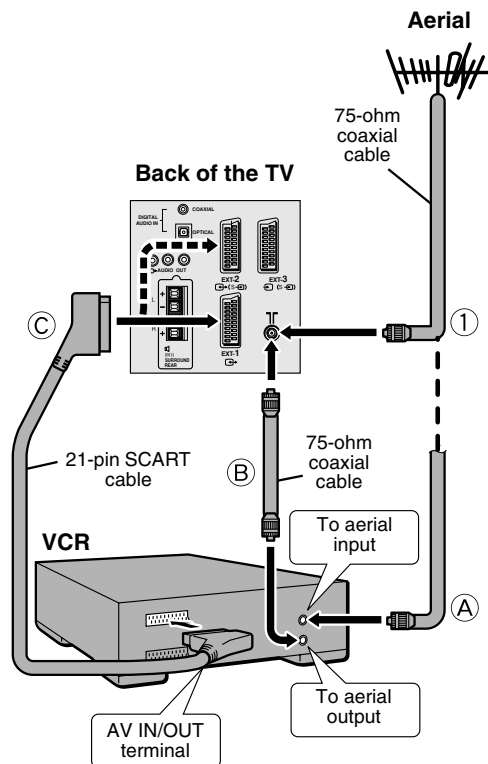

■ Connecting the power cord to the mains outlet

Caution:

- Use only the power source specified on the unit (AC 220 – 240 V, 50 Hz).

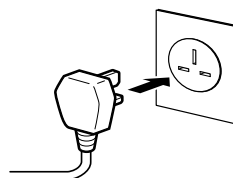

■ Putting batteries into the remote control

Use two AAA/R03 dry cell batteries.

Insert the batteries holding the ⊖ end, making sure the ⊕ and ⊖ terminals are correctly lined up.

To open the battery compartment, slide the door downwards and lift off. Replace the door by sliding it upwards until it fastens into place.

- Follow the warnings printed on the batteries.
- Battery life is about six months to one year, depending on how much you use the remote control.
- If the remote control does not work properly, fit new batteries.
- The batteries we supply are only for setting up and testing your TV. Please replace them as soon as you need to.
- Always use good-quality batteries.

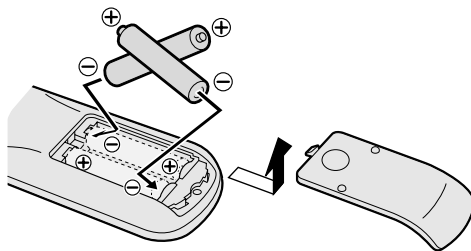

■ Initial settings

When the TV is first turned on, it goes into the initial setting mode, and you will see the JVC logo. Follow the instructions on the screen to make the initial settings.

1 Press the main power button on the TV

The power lamp lights red (for power on), then green (for TV on) and the JVC logo appears.



D0001-EK

- If the power lamp stays red and does not change to green:
your TV is in the standby mode. Press the (standby) button on the remote control to turn your TV on.
- If the JVC logo does not appear this is because your TV has already been turned on for the first time:
use the "LANGUAGE" and "AUTO PROGRAM" functions to make the initial settings. For details, see "INSTALL" on page 30.

2 Press the OK button

The LANGUAGE menu appears.

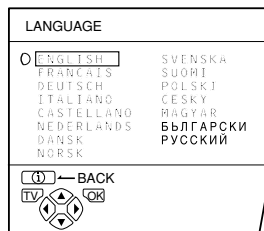

D0002(E)-EK

3 Press the ◀▶ and ▼▲ buttons to choose ENGLISH

The on-screen display will then be in English.

<AV32P10EK and AV32P10EI>

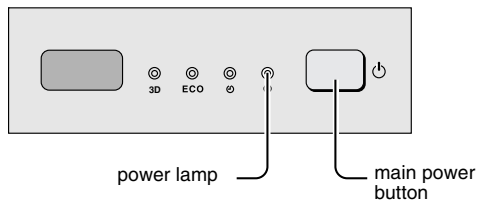

<AV32L5EK and AV32L5EI>

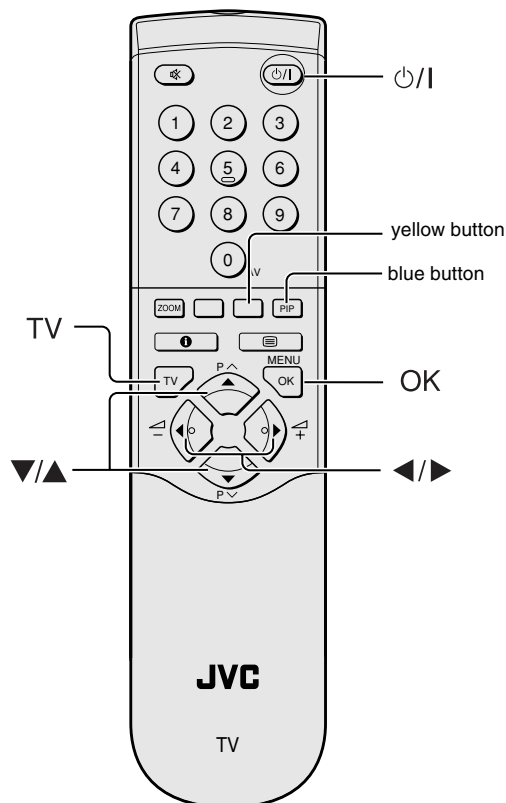
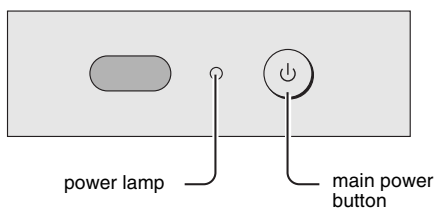

4 Press the OK button to start the AUTO PROGRAM function

The AUTO PROGRAM menu appears and the TV channels you receive are automatically stored in the programme numbers list (PR).

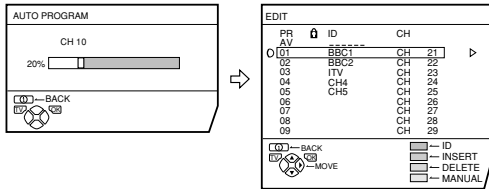

D0004-EK

If “ACI START/ACI SKIP” appears in the AUTO PROGRAM menu:

You can use the ACI (Automatic Channel Installation) function to decode the ACI data and complete the registration of all the TV channels quickly. For details of the ACI function and how to use it, refer to “Using the ACI function” on page 35.

If you don't want to use the ACI function, press the $\blacktriangledown/\blacktriangle$ button to choose ACI SKIP and then press **OK**.

To cancel the AUTO PROGRAM function:

Press the **TV** button.

5 After the TV channels have been registered in the programme numbers list (PR), the EDIT menu appears

If you want to, you can now edit the programme numbers (PR) using the EDIT/MANUAL function. For details, see “EDIT/MANUAL” on page 31.

If you do not want to edit programme numbers (PR), go to the next step.

6 Press the OK button to display the T-V LINK menu

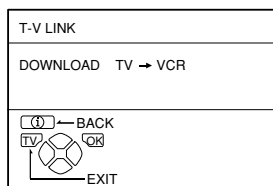

D0005-EK

7 Follow the T-V LINK menu according to the type of VCR you have connected to the EXT-2 terminal

If you do not have a T-V LINK compatible VCR connected:

Press the **TV** button to leave the T-V LINK menu.

The T-V LINK menu disappears.

If you have a T-V LINK compatible VCR connected:

Follow the operating procedure “Downloading data to a VCR” on page 35 to transmit the programme number (PR) data.

8 Now, the initial settings are complete, and you can watch the TV

Note:

• **For UK model (AV32P10EK/AV32L5EK):**

BBC1, BBC2, ITV, Channel 4 and Channel 5 are automatically set to the programme numbers PR1 to PR5.

If the TV doesn't receive one of these TV channels, that programme number (PR) will not be set. Programme number PR6 is not normally set.

• **For Ireland model (AV32P10EI/AV32L5EI):**

If your TV can detect the TV channel name from the TV channel broadcast signal, the TV channel name is assigned to the programme number (PR) to which the TV channel has been set.

However, which TV channels are set to which programme numbers (PR) will depend on the area in which you live.

- If a TV channel you want to view is not set to a programme number (PR), you can set it using the MANUAL function. For details, see “EDIT/MANUAL” on page 31.
- The AUTO PROGRAM function does not set the programme number PR 0 (AV) for your video cassette recorder. You will need to set this using the MANUAL function.
- In some areas you may get TV reception from more than one transmitter, for example different ITV regions. In this case each TV channel could be set twice. If this happens, the first set of channels will have the stronger signal. If you want to delete the second set of channels, you will have to do it manually (see page 33).

For users in the UK:

If you have any problems setting up your new TV, please call the **JVC** Helpline on **0870 330 5000**.

For users in the Republic of Ireland:

If you have any problems setting up your new TV, please contact your local **JVC** dealer.

T-V LINK functions

When you have a T-V LINK compatible VCR connected to the EXT-2 Terminal on the TV, it is easier to set up the VCR and to view videos. T-V LINK uses the following features:

■ Pre-set download

The VCR will automatically download the registered data on the TV channels from the TV. This means you do not need to set up the program channels on your VCR manually. The preset download function automatically begins when the initial setting is complete or whenever you carry out the AUTO PROGRAM or EDIT/MANUAL functions.

You can also carry out this function using your VCR controls.

When "FEATURE NOT AVAILABLE" is displayed:

If "FEATURE NOT AVAILABLE" is displayed, the download was not performed correctly. Before trying to download again, check that:

- the VCR power is turned on
- the VCR is T-V LINK compatible
- the VCR is connected to the EXT-2 terminal
- the SCART cable is fully wired

■ Direct Rec

"What You See Is What You Record"

You can easily record to VCR the images that you are watching on the TV.

For details, read the manual for your VCR. Use your VCR controls. "VCR IS RECORDING" is displayed.

In the following situations, the VCR will stop recording if the TV is turned off, if the TV channel or input is changed, or if the menu is displayed on the TV:

- when recording images from an external device connected to the TV (for example a camcorder)
- when recording a TV channel after it has been unscrambled on a decoder
- when recording a TV channel by using the TV's output because the VCR's own tuner cannot properly receive that channel
- You cannot carry out Direct Rec using your TV's control.
- Generally, the VCR cannot record a TV channel that it cannot receive properly on its own tuner, even if you can view that TV channel on the TV. However, some VCRs can record a TV channel by using the TV's output if that channel can be viewed on the TV. For details, see your VCR instruction manual.

■ TV auto power on/VCR image view

When the VCR starts playing, the TV automatically turns on and the images from the EXT-2 terminal appear on the screen.

When the VCR menu is operated, the TV automatically turns on and the images from the EXT-2 terminal appear on the screen.

This function does not happen if your TV's main power is turned off. Set your TV's main power to on (standby mode).

Note:

- A "T-V LINK compatible VCR" means a JVC video cassette recorder with the T-V LINK logo, or with one of the following logos. However, these VCRs may support some or all of the features described earlier. For details, see your VCR instruction manual.

"Q-LINK" (a trademark of Panasonic Corporation)

"Data Logic" (a trademark of Metz Corporation)

"Easy Link" (a trademark of Phillips Corporation)

"Megalogic" (a trademark of Grundig Corporation)

"SMARTLINK" (a trademark of Sony Corporation)

Using your TV—the basics

■ Turn the main power on

Press the main power button on the TV

The power lamp lights red and your TV is in the standby mode.

If the power lamp lights green, the TV is already on.

To turn the main power off:

Press the main power button again.

The power lamp goes off.

The main power button on the TV does not fully cut the TV off from the mains supply. If you are not going to use this TV for a long time, be sure to pull the mains plug out of the mains outlet.

<AV32P10EK and AV32P10EI>

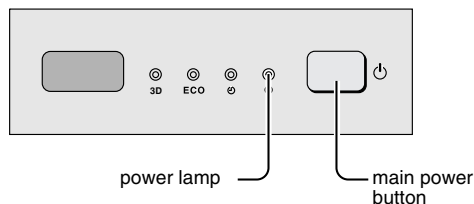

<AV32L5EK and AV32L5EI>

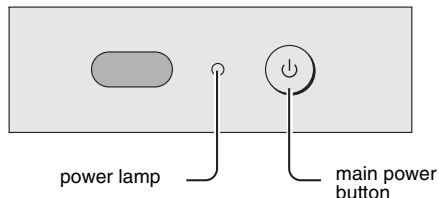

■ Turn the TV on from standby mode

Press the O/I (standby) button, the TV button, the ∇/\blacktriangle buttons or the number buttons

The power lamp goes from red to green and your TV will be turned on.

To turn the TV off:

Press the O/I (standby) button again.

The power lamp changes from green to red and the TV goes into standby mode.

■ Choose a TV channel

Choose the programme number (PR) that the TV channel has been set to.

Use the ∇/\blacktriangle buttons:

Press the ∇/\blacktriangle buttons to choose the programme number (PR) you want.

Use the number buttons:

Enter the programme number (PR) of the channel using the number buttons.

Example

- PR12 → press 1 and 2.
- PR6 → press 6.

Use the PR LIST:

- 1 Press the i (information) button to display the PR LIST

PR LIST	
PR	ID
AV	-----
01	BBC1
02	BBC2
03	ITV
04	CH4
05	CH5
06	
07	
08	
09	

-10 +10

00006-EK

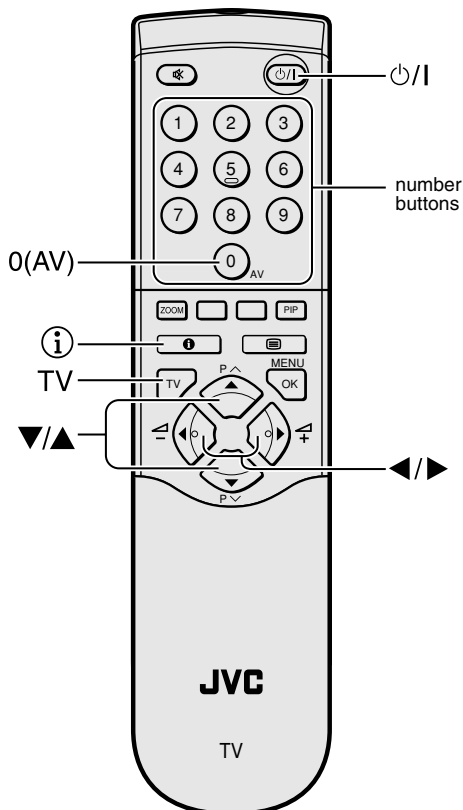

2 Press the ◀/▶ and ▼/▲ buttons to choose a programme number (PR). Then press the OK button

- For programme numbers (PR) where you have the CHILD LOCK function set, the **Ⓛ** (CHILD LOCK) mark appears next to the programme number (PR) in the PR LIST.
- You cannot use the ▼/▲ buttons to choose a programme number (PR) which has the CHILD LOCK set.
- Even if you try to choose a programme number (PR) with the CHILD LOCK set, the **Ⓛ** (CHILD LOCK) mark will appear, and you cannot watch the TV channel. To watch the TV channel, see “CHILD LOCK” on page 28.
- If the picture is tilted, correct it. See “PICTURE TILT” on page 20.

■ Changing the volume

Press the ◀/▶ buttons to change the volume.

The volume indicator appears, and the volume changes, as you press the -/+ buttons.

To listen to the sound using headphones:
See “HEADPHONE” on page 22.

■ Watching images from external equipment

Choose the EXT terminal that the external equipment has been connected to.

Use the 0 (AV) button:

Press the 0 (AV) button to choose an EXT terminal.
Pressing the 0 (AV) button changes the choice as follows:

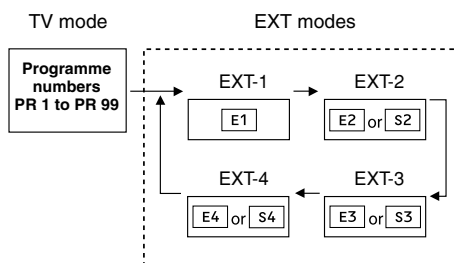

Use the ▼/▲ buttons:

Press the ▼/▲ buttons to choose an EXT terminal

Use the PR LIST:

1 Press the **i** (information) button to display the PR LIST

2 Press the ◀/▶ and ▼/▲ buttons to choose an EXT terminal. Then press the OK button

- The EXT terminals are listed after programme number PR 99.
- You can choose two types of video input signal: S-VIDEO (Y/C signal) and regular video (composite signal). For details, see “S-IN (S-VIDEO input)” on page 26.
- When listening to Dolby Digital audio, see “Listening to Dolby Digital audio (Only AV32P10EK and AV32P10EI)” on page 38.
- If you do not have a clear picture or no colour appears, change the colour system manually. See “COLOUR SYSTEM” on page 20.
- If you choose an EXT terminal with no input signal, the EXT terminal number becomes fixed on the screen.
- This TV set can automatically change over the input according to a special signal from an external device. (The EXT-4 terminal does not support it.)

To use the programme number PR 0 (AV):

When the TV and VCR are connected only by the aerial cable, choosing the programme number PR 0 (AV) allows you to view images from the VCR. Set the VCR RF channel to programme number PR 0 (AV) manually. For details, see “EDIT/MANUAL” on page 31.

Pressing the 0 (AV) button changes the choice as follows:

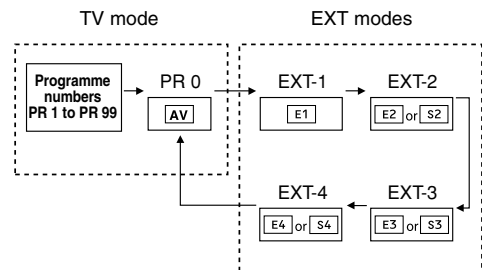

- The VCR sends its playback image along the aerial cable as an RF (radio frequency) signal.
- Also see your VCR instruction manual.

To return to a TV channel:

Press the **TV** button, the ▼/▲ buttons or the number buttons.

■ Using the buttons on the TV

1 Press the P ∇/\wedge buttons to turn the TV on from standby mode

2 Press the P ∇/\wedge buttons to choose a programme number (PR) or an EXT terminal

3 Press the \triangleleft (volume) button and the $-/+$ buttons to change the volume

1 Press the \triangleleft (volume) button

The volume level indicator appears

2 Press the $-/+$ buttons while the volume level indicator is on screen

- The buttons on the TV cannot be used to change the volume of the headphones.

<AV32P10EK and AV32P10EI>
Behind the Cover

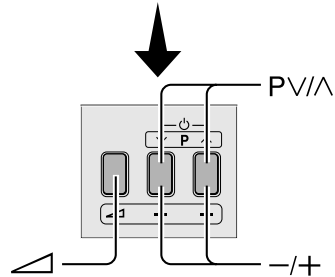
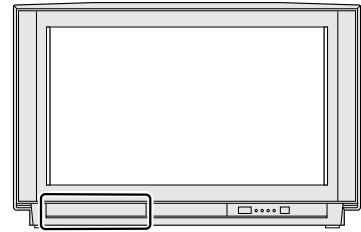

<AV32L5EK and AV32L5EI>
Side of the TV

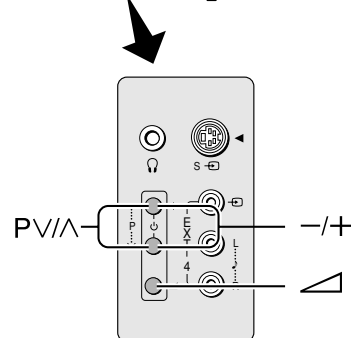
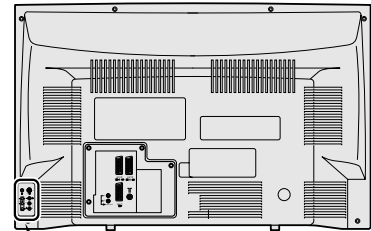

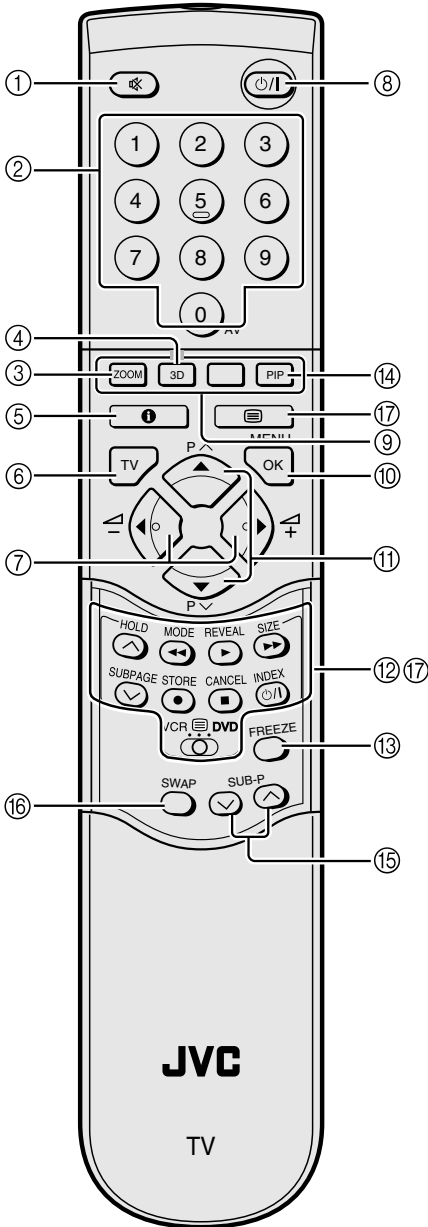

Remote control buttons and functions



① Muting button

You can turn the sound off instantly.

Press the  (muting) button to turn off the sound. Pressing the  (muting) button again restores the previous volume level



② Number buttons

You can choose a programme number (PR) by entering the programme number

Example:

- PR12 → press 1 and 2.
- PR6 → press 6.

You can also press the 0 (AV) button repeatedly to choose an EXT terminal.

③ ZOOM button

You can change the screen size by changing the picture aspect ratio. The normal aspect ratio is 4:3 (width:height). Choose the ideal one from the following ZOOM modes.

AUTO:

For any picture format except normal picture (4:3 aspect ratio), the picture will be automatically displayed in the ideal screen size.

For normal picture (4:3 Aspect Ratio), you can choose a ZOOM mode from the 4:3 AUTO ASPECT menu. For details, see "4:3 AUTO ASPECT" on page 20.

- AUTO may not work properly with poor signal quality. In this case, choose the best ZOOM mode manually.
- This TV supports WSS (wide-screen signals). When broadcasts with WSS are received with the ZOOM mode set at AUTO, the most suitable ZOOM mode is automatically chosen according to the WSS received.

REGULAR:

Use to view a normal picture (4:3 aspect ratio) as this is its original shape.



PANORAMIC:

This stretches the left and right sides of a normal picture (4:3 aspect ratio) to fill the screen, without making the picture appear unnatural.

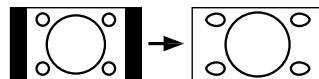

- The top and bottom of the picture are slightly cut off.

14:9 ZOOM:

This zooms up the wide picture (14:9 aspect ratio) to the upper and lower limits of the screen.

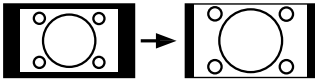

16:9 ZOOM:

This zooms up the wide picture (16:9 aspect ratio) to the full screen.

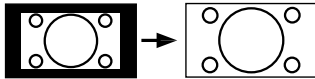

16:9 ZOOM SUBTITLE:

This zooms up the wide picture (16:9 aspect ratio) with subtitles to the full screen.

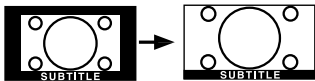

FULL:

This uniformly stretches the left and right sides of a normal picture (4:3 aspect ratio) to fill the wide TV screen.

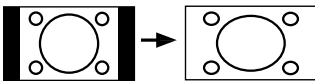

- For 16:9 aspect ratio pictures that have been squeezed into a normal picture (4:3 aspect ratio), use the FULL mode to restore the picture to its original shape.

Choose the ZOOM mode

- 1 Press the ZOOM button to display the ZOOM menu

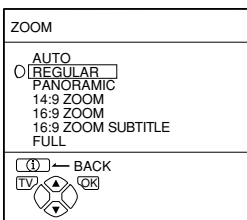

D0009-EK

- 2 Press the ▼/▲ buttons to choose a ZOOM mode. Then press the OK button

The picture expands and the chosen ZOOM mode is displayed in about 5 seconds.

- The ZOOM mode may be automatically changed by the control signal from an external device. When you want to return to the previous ZOOM mode, choose the ZOOM mode again.

Adjusting the visible area of the picture

If subtitles or the top (or bottom) of the picture are cut off, you can adjust the visible area of the picture manually.

- 1 Press the ZOOM button

The ZOOM menu appears.

- 2 Press the OK button to display the ZOOM mode indicator

The indicator appears.

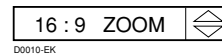

D0010-EK

- 3 While it is displayed, press the ▼/▲ buttons to change the height of the picture

- You cannot adjust the visible area in REGULAR or FULL mode.

- 4 **3D Button (Only AV32P10EK and AV32P10EI)**

You can turn the 3D-PHONIC function on or off by one-touch operation.

Press the 3D button

Pressing the 3D button changes the function as follows:

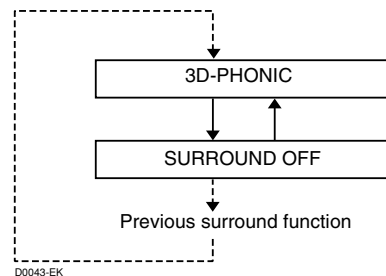

D0043-EK

- For details, see "3D-PHONIC" on page 23.
- If another surround function is activated before you press the 3D button, you can return to that surround function.
- The 3D button does not work while the headphones are connected to the TV.

⑤ Information button

You can display the PR LIST or the current time on the screen.

Press the **i** (information) button

Pressing the **i** (information) button changes the display as follows:

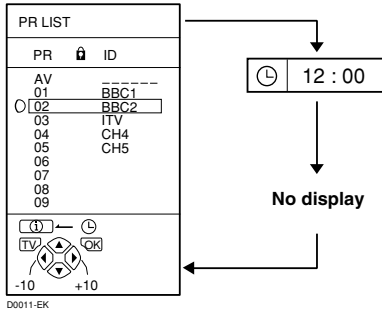

- You can choose programme numbers (PR) or EXT terminals with the PR LIST. For details, see “Use the PR LIST:” on page 8.
- This TV uses teletext data to set the time. If the TV has not received a TV channel that has teletext programmes since it was turned on, the time display is blank. To see the time, choose a TV channel that has teletext programmes. The time will still be displayed as long as you do not turn off the TV, even if you choose other TV channels.
- When watching videos, the incorrect time is sometimes displayed.
- The **i** (information) button will also operate menus. For details, see “Using the TV’s menus” on page 17.

⑥ TV button

You can return to a TV channel instantly.

Press the **TV** button.

The TV returns to the TV mode and a TV channel appears.

- The **TV** button will also operate menus. For details, see “Using the TV’s menus” on page 17.

⑦ ◀/▶ Buttons

You can adjust the volume.

Press the ◀/▶ buttons to adjust the sound.

- The ◀/▶ buttons will also operate menus. For details, see “Using the TV’s menus” on page 17.

⑧ Standby button

Press the **⏻/⏻** (standby) button to turn the TV on or off.

When the TV is turned on, the power lamp changes from red to green.

⑨ Colour buttons

The colour buttons are used for the teletext operations or the menu operations. For details, see “**⑰** Teletext control buttons and VCR **⏻** DVD switch” on page 15 or “Using the TV’s menus” on page 17.

⑩ OK button

The **OK** button is used to operate menus. For details, see “Using the TV’s menus” on page 17.

⑪ ▼/▲ Buttons

You can choose a programme number (PR) or an EXT terminal.

Press the ▼/▲ buttons to choose a Programme number (PR) or an EXT terminal.

The ▼/▲ buttons will also operate menus. For details, see “Using the TV’s menus” on page 17.

⑫ VCR/DVD control buttons and VCR **⏻** DVD switch

These buttons will operate a JVC brand VCR or DVD player. Pressing a button that looks the same as the device’s original remote control button has the same effect as the original remote control.

1 Set the VCR **⏻** DVD switch to the VCR or DVD position.

VCR:

When you are using a VCR, set the switch to the VCR position.

DVD:

When you are using a DVD player, set the switch to the DVD position.

2 Press the VCR/DVD control button to control your VCR or DVD player

- If your device is not made by JVC, these buttons will not work.
- Even if your device is made by JVC, some of these buttons may not work, depending on the device you are using.
- You can use the ▼/▲ buttons to choose a TV channel the VCR will receive, or choose the chapter the DVD player plays back.
- Some models of DVD player use the ▼/▲ buttons for both operating the fast forward/backward functions and for choosing the chapter. In this case, the ◀/▶ buttons do not work.

13 FREEZE button

You can view the current programme as a still picture.

1 Press the FREEZE button

The still picture of the current picture will appear.

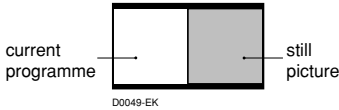

To cancel the FREEZE function:

Press the FREEZE button again.

- The FREEZE function does not work while a sub-picture is displayed.
- The still picture cannot be output from the TV.

14 15 16 PIP control buttons

You can view two pictures (Main-picture and sub-picture). You can view a TV programme received by the TV and a video programme from an external device at the same time.

- If a device which can receive broadcast programmes (such as a satellite tuner or VCR) is connected to the TV's EXT terminal, both the broadcast programme received by that device and the broadcast programme received by the TV can be viewed at the same time.
- With just the TV, two broadcast programmes cannot be viewed at the same time.

1 Press the PIP button 14

Pressing the PIP button changes the PIP mode as follows:

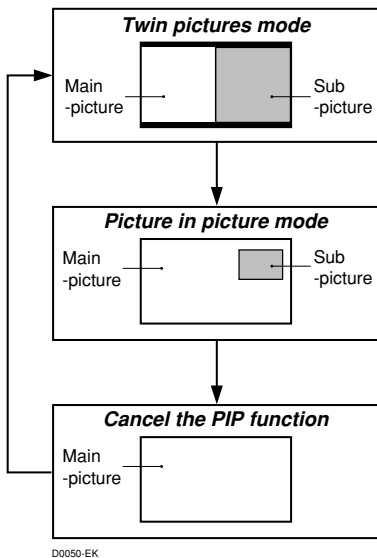

- When the PIP button is pressed while watching a TV programme, the picture from an EXT terminal is displayed as the sub-picture. Press the SUB-P V/Λ buttons 15 to change the sub-picture to the picture from another EXT terminal.

- When the PIP button is pressed while watching a picture from an EXT terminal, the picture from a TV channel or the picture from another EXT terminal is displayed as the sub-picture. Press the SUB-P V/Λ buttons 15 to change the sub-picture to the picture from another TV channel or another EXT terminal.
- The main-picture and sub-picture must be different.
- If the main-picture signal is poor, the quality of the sub-picture may also be poor.
- If the pictures have different standards, the top and bottom of one of them may be missing.
- The sub-picture will disappear if the TV receives a control signal from the external device.
- The ZOOM function does not work in the twin-picture mode.
- The STEREO / I • II function does not work in the EXT modes even if you are viewing a TV programme in the sub-picture.
- The BLUE BACK function does not work in the twin picture mode or the picture in picture mode.
- The sub-picture cannot be output from the TV.

Listening to the sound of the sub-picture:

You can listen to the sound of the sub-picture with the headphones while listening to the sound of the main-picture from the TV speakers.

For details, see "HEADPHONE" on page 22.

Changing the position of the sub-picture:

You can choose one of four positions.

For details, see "PIP POSITION" on page 20.

Swapping the main-picture and sub-picture:

Press the SWAP button 16 .

The main-picture and sub-picture will be swapped.

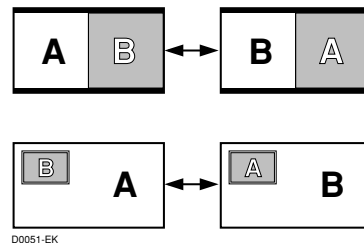

17 Teletext control buttons and VCR DVD switch

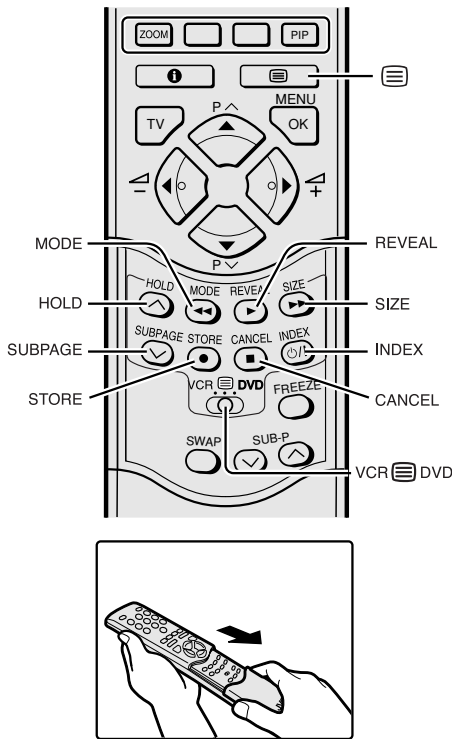

4 Choose a teletext page by pressing the ▼/▲ buttons, number buttons or colour buttons

To return to the TV mode:

Press the **TV** button or (Text) button.

- If you have trouble receiving teletext broadcasts, contact your local dealer or the teletext station.
- The ZOOM function will not work in the text mode or TV and text mode.
- You cannot operate menus when viewing a teletext programme.
- Teletext programmes cannot be viewed while a sub-picture is displayed.

Using the List Mode

You can store the numbers of your favourite teletext pages in memory and call them up quickly using the colour buttons.

To store the page numbers:

1 Press the **MODE** button to go into the List mode

The page numbers you have stored are displayed at the bottom of the screen.

2 Press a colour button to choose a position. Then press the number buttons to enter the page number

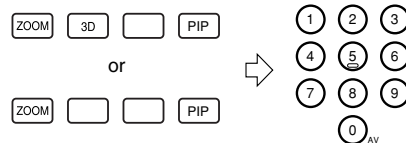

3 Press and hold down the **STORE** button

The four page numbers blink white to show that they are stored in memory.

To call up a stored page:

1 Press the **MODE** button to enter the List mode

2 Press a colour button having a stored page

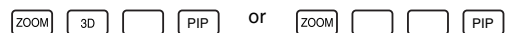

To leave the List mode:

Press the **MODE** button again.

Basic operation

You can view two types of teletext broadcasts on the TV: FLOF (Fastext) and WST (World Standard Text).

1 Choose a TV channel with a teletext broadcast

2 Set the VCR DVD switch to the (Text) position



3 Press the (Text) button to display the teletext

Pressing the (Text) button changes the mode as follows:

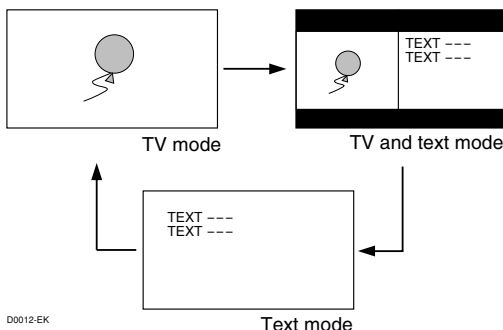

Hold

You can hold a teletext page on the screen for as long as you want, even while several other teletext pages are being received.

Press the HOLD button

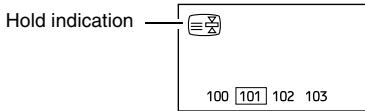

To cancel the Hold function:

Press the **HOLD** button again.

Sub-page

Some teletext pages include sub-pages that are automatically displayed.

You can hold any sub-page, or view it at any time.

1 Press the SUBPAGE button to operate the sub-page function

Sub-page numbers are displayed at the left of the screen.

Colour*	Meaning of sub-page number
Yellow	Currently being displayed.
White	Can be displayed.
Blue or Red	Cannot be displayed and it is not sent.

* Background colour of the sub-page number.

2 Press the ▼/▲ buttons to choose a subpage number.

To cancel the sub-page function:

Press the **SUBPAGE** button again.

Reveal

Some teletext pages include hidden text (such as the answers to a quiz).

You can display the hidden text.

Each time you press the REVEAL button, text is hidden or revealed

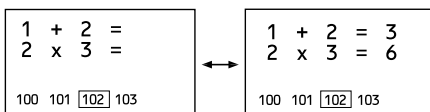

Size

You can double the height of the teletext display.

Press the SIZE button.

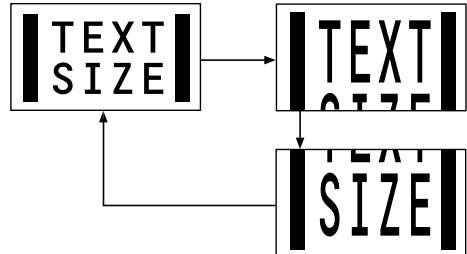

Index

You can return to the index page instantly.

Press the INDEX button

FLOF (Fastext)/WST (World Standard Text):
Returns to page 100 or a previously specified page.

List mode:
Returns to the page number displayed in the lower left area of the screen.

Cancel

You can search for a teletext page while watching TV.

1 Press the number button to enter a page number, or press a colour button

The TV searches for a teletext page.

2 Press the CANCEL button.

The TV programme appears. When the TV finds the teletext page, its page number appears in the upper left of the screen.

3 Press the CANCEL button to return to a teletext page when the page number is on the screen

Note:

- The TV mode cannot be resumed by pressing the **CANCEL** button. To return to the TV mode press **TV**.

Using the TV's menus

This TV has a number of functions you can operate using menus. To use all your TV's functions fully, you need to understand how to use the basic menus.

1 Press the OK button to display the MENU (main menu)

The MENU (main menu) appears. In it, the titles of the menus are displayed.

<AV32P10EK and AV32P10EI>

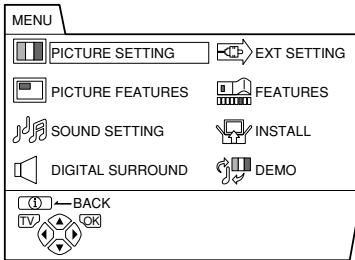

D0052-EK

- The title of the DIGITAL SURROUND menu is not displayed while the headphones are connected to the TV.

<AV32L5EK and AV32L5EI>

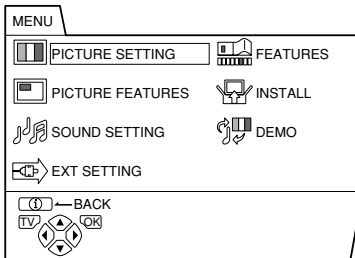

D0013-EK

- AV32L5EK and AV32L5EI do not have DIGITAL SURROUND menu.

2 Press the ▼/▲ buttons to choose a menu title, and press the OK button

The menu appears.

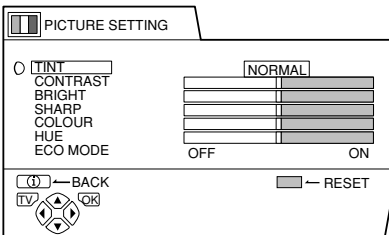

D0014-EK

3 Follow the menus according to the function you want to use

- For more details, see the descriptions of each menu and its functions on the following pages.
- The display appearing at the bottom of a menu shows you a button on the remote control that you can use when you operate a chosen function.

4 Press the OK button to complete the setting

The menu disappears.

To return to the previous menu:

Press the **ⓘ** (information) button.

To exit a menu instantly:

Press the **TV** button.

- When watching the television with the NTSC system, the menus are displayed at about half of their normal vertical size.

Picture setting

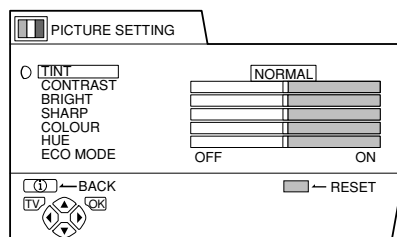

D0014-EK

To display the PICTURE SETTING menu:

- 1 Press the **OK** button to display the MENU (main menu)
- 2 Press the **▼/▲** buttons to choose PICTURE SETTING, and press the **OK** button

■ TINT

You can select one of three TINT modes (three kinds of picture settings) to adjust the picture settings automatically.

- 1 Press the **▼/▲** buttons to choose TINT
- 2 Press the **◀/▶** buttons to choose a mode

COOL:

A cool white colour base with a boost in the colour and contrast levels that creates a more vivid picture.

WARM:

A warm orange/red colour base that creates the appropriate colour and contrast levels for watching films.

NORMAL:

A normal white colour base with normal colour and contrast levels.

- 3 Press the **OK** button to complete the setting

The menu disappears.

■ Picture adjustment

You can change the picture settings of each TINT mode as you like.

The picture settings changed are stored in the TINT mode.

- 1 Press the **▼/▲** buttons to choose an item.
- 2 Press the **◀/▶** buttons to change the setting.

◀	Item	▶
Lower	CONTRAST (picture contrast)	Higher
Darker	BRIGHT (picture brightness)	Brighter
Softer	SHARP (picture sharpness)	Sharper
Lighter	COLOUR (picture colour)	Deeper
Reddish	HUE (picture hue)	Greenish

- You can change the HUE setting (picture hue) only when the colour system is NTSC 3.58 or NTSC 4.43. (See "Specifications" on page 43 and the back cover.)

To return to the default settings in each TINT mode:

Press the blue button.

This returns the picture settings in the TINT mode you have chosen to the default settings, and stores them in the TINT mode.

- 3 Press the **OK** button to complete the settings

The menu disappears.

■ ECO MODE

When you set the ECO MODE function to ON, the screen contrast is automatically adjusted to a setting suitable for the brightness of your room. This reduces eye strain for you and the amount of power the TV uses.

- 1 Press the **▼/▲** buttons to choose ECO MODE

- 2 Press the **◀/▶** buttons to choose ON

To cancel the ECO MODE function:

Press the **◀/▶** buttons to choose OFF.

- 3 Press the **OK** button to complete the setting

The menu disappears.

Picture features

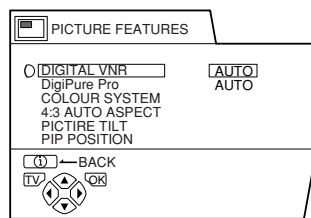

D0015-EK

To display the PICTURE FEATURES menu:

- 1 Press the **OK** button to display **MENU** (main menu)
- 2 Press the **▼/▲** buttons to choose **PICTURE FEATURES**, and press the **OK** button

■ DIGITAL VNR

The DIGITAL VNR function cuts down the amount of noise (graininess) in the original picture.

You can choose from the three DIGITAL VNR function settings of AUTO, MIN and MAX.

- If you set the DIGITAL VNR effect too high it can make the picture less sharp. We recommend you use the AUTO setting if you can.

- 1 Press the **▼/▲** buttons to choose **DIGITAL VNR**
- 2 Press the **◀/▶** buttons to choose a setting

AUTO:

The TV will automatically adjust the level of the DIGITAL VNR effect to match the amount of noise in the picture, giving you the best possible picture.

MIN:

The level of the DIGITAL VNR effect is set to the minimum. If you set the DIGITAL VNR function to AUTO but feel that the sharpness of the original picture has not been reproduced fully, change the setting from AUTO to MIN.

- The MIN setting is not suitable for low-quality pictures which contain a lot of noise.

MAX:

The level of the DIGITAL VNR effect is set to the maximum. If you set the DIGITAL VNR function to AUTO but still notice some noise, change the setting from AUTO to MAX.

- The MAX setting is not suitable for high-quality pictures which contain very little noise.

- 3 Press the **OK** button to complete the setting

The menu disappears.

■ DigiPure Pro

The DigiPure Pro function uses the latest in digital technology to give you a natural-looking picture. The DigiPure Pro function includes the following two functions.

DigiPure function:

This function helps to create a natural-looking picture by eliminating unnecessary edges from high-contrast and crisp images. For images with low-contrast, edges are added to produce a sharper, more detailed picture.

You can choose from the three DigiPure function settings of AUTO, MIN and MAX.

- If you set the DigiPure effect too high on a low-quality picture that contains a lot of noise, this may actually make the noise worse. We recommend you use the AUTO setting if you can.

Picture motion compensation function:

This function displays fast-moving pictures (for example, the players or ball in a football game) more smoothly and naturally on the screen.

- The effect level of the picture motion compensation function cannot be changed. The effect level is the same no matter which of the AUTO, MIN or MAX settings is used.

- 1 Press the **▼/▲** buttons to choose **DigiPure Pro**
- 2 Press the **◀/▶** buttons to choose a setting

AUTO:

The TV will automatically adjust the level of the DigiPure effect to match the amount of noise in the picture, giving the best possible picture.

MIN:

The level of DigiPure effect is set to the minimum. When you set the DigiPure Pro function to AUTO and notice some noise, change the setting from AUTO to MIN.

- The MIN setting is not suitable for high-quality pictures which contain very little noise.

MAX:

The level of DigiPure effect is set to the maximum. If you set the DigiPure Pro function to AUTO but feel that the original picture quality has not been reproduced fully, change the setting from AUTO to MAX.

- The MAX setting is not suitable for low-quality pictures which contain a lot of noise.

OFF:

The DigiPure Pro function is turned off.

- 3 Press the **OK** button to complete the setting

The menu disappears.

■ COLOUR SYSTEM

The colour system is chosen automatically. However, if the picture is not clear or no colour appears, choose the colour system manually.

- 1 Press the **▼/▲** buttons to choose **COLOUR SYSTEM**. Then press the **OK** button

The sub-menu of the COLOUR SYSTEM function appears.

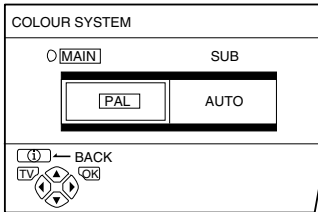

D0016-EK

- 2 Press the **◀/▶** buttons to choose **MAIN** or **SUB**
MAIN:

You can change the colour system of the main-picture.

SUB:

You can change the colour system of the sub-picture.

- Choose MAIN when a sub-picture is not displayed.

- 3 Press the **▼/▲** buttons to choose the appropriate colour system

PAL:

PAL system

NTSC 3.58:

NTSC 3.58 MHz system

NTSC 4.43:

NTSC 4.43 MHz system

AUTO:

This function detects a colour system from the input signal. You can only use this when you are viewing a picture from programme number PR 0 (AV), or an EXT terminal.

- 4 Press the **OK** button to complete the setting

The menu disappears.

- The AUTO function may not work properly if you have poor signal quality. If the picture is abnormal in the AUTO function, choose another colour system manually.
- You cannot choose NTSC 3.58 or NTSC 4.43 for programme numbers PR 0 (AV) to PR 99.

■ 4:3 AUTO ASPECT

You can choose one of three ZOOM modes, REGULAR, PANORAMIC or 14:9 ZOOM, as the ZOOM mode for the normal picture (4:3 aspect ratio).

- 1 Press the **▼/▲** buttons to choose **4:3 AUTO ASPECT**. Then press the **OK** button

The sub-menu of the 4:3 AUTO ASPECT function appears.

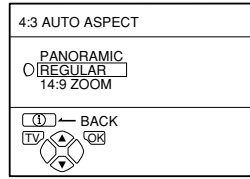

D0017-EK

- 2 Press the **▼/▲** buttons to choose a **ZOOM** mode

- 3 Press the **OK** button to complete the setting

The menu disappears.

■ PICTURE TILT

Sometimes the Earth's own magnetic field may make the picture tilt. If this happens, you can correct the picture tilt.

- 1 Press the **▼/▲** buttons to choose **PICTURE TILT**. Then press the **OK** button

The sub-menu of the PICTURE TILT function appears.

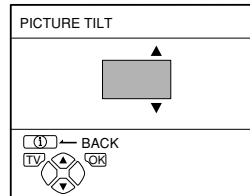

D0018-EK

- 2 Press the **▼/▲** buttons until the picture becomes level

- 3 Press the **OK** button to complete the setting

The menu disappears.

■ PIP POSITION

You can choose one of four positions for the sub-picture.

- 1 Press the **▼/▲** buttons to choose **PIP POSITION**. Then press the **OK** button

The PIP POSITION menu appears.

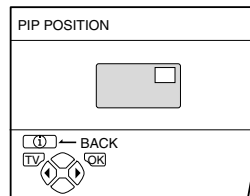

D0053-EK

- 2 Press the **◀/▶** buttons to choose the position

- 3 Press the **OK** button to complete the setting

The menu disappears.

Sound setting

<AV32P10EK and AV32P10EI>

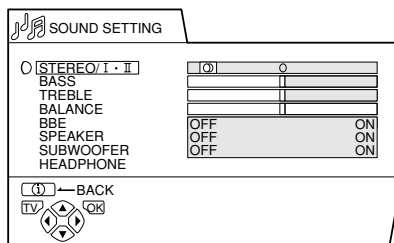

D0054-EK

<AV32L5EK and AV32L5EI>

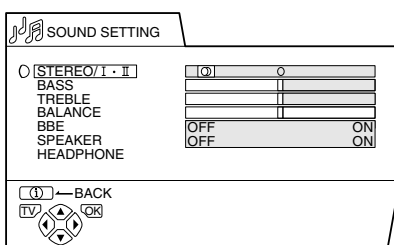

D0019-EK

To display the SOUND SETTING menu:

- 1 Press the **OK** button to display the MENU (main menu)
- 2 Press the **▼/▲** buttons to choose **SOUND SETTING**. Then press the **OK** button

■ STEREO / I · II

When you are viewing a bilingual broadcast programme, you can choose the sound from Bilingual I (Sub I) or Bilingual II (Sub II). If you have poor reception on a stereo broadcast, you can change from stereo to mono sound so that you can hear the broadcast more clearly and easily.

- 1 Press the **▼/▲** buttons to choose **STEREO / I · II**
- 2 Press the **◀/▶** buttons to choose a sound mode
 - ◐ : Stereo sound
 - : mono sound
 - I : Bilingual I (sub I)
 - II : Bilingual II (sub II)
- 3 Press the **OK** button to complete the setting

The menu disappears.

- The sound mode you can choose differs depending on the TV programme.
- This function does not work in the EXT modes. And this function does not appear in the SOUND SETTING menu.

■ Sound adjustment

You can adjust the sound to your liking.

- 1 Press the **▼/▲** buttons to choose an item
- 2 Press the **◀/▶** buttons to adjust it

◀	Item	▶
Weaker	BASS	Stronger
Weaker	TREBLE	Stronger
Left	BALANCE	Right

- 3 Press the **OK** button to complete the setting

The menu disappears.

■ BBE

You can use the BBE function to enjoy easy-to-listen sound that is faithful to the original sound recorded.

- 1 Press the **▼/▲** buttons to choose **BBE**.
- 2 Press the **◀/▶** buttons to choose **ON**.

To cancel the BBE function:

Press **◀/▶** buttons to choose **OFF**.

- 3 Press the **OK** button to complete the setting.

The menu disappears.

- Licensed by BBE Sound, Inc. BBE is a registered trademark of BBE Sound, Inc.

■ SPEAKER

Set the SPEAKER function to OFF when external front speakers are connected to the TV. If the SPEAKER function is set to OFF, no sound comes from the TV speakers.

- 1 Press the **▼/▲** buttons to choose **SPEAKER**
- 2 Press the **◀/▶** buttons to choose **ON** or **OFF**
- 3 Press the **OK** button to complete the setting

The menu disappears.

- To hear sound from the TV speakers, set the SPEAKER function to ON.
- The "SPEAKER" item is not displayed when the 3D-PHONIC function or DOLBY DIGITAL function are operating. (Only AV32P10EK and AV32P10EI)

■ SUBWOOFER (Only AV32P10EK and AV32P10EI)

Set the SUBWOOFER function to ON when the subwoofer is connected to the TV.

- 1 Press the ▼/▲ buttons to choose **SUBWOOFER**
- 2 Press the ◀/▶ buttons to choose **ON** or **OFF**
- 3 Press the **OK** button to complete the setting

The menu disappears.

- Set the SUBWOOFER function to OFF when the subwoofer is not connected to the TV.
- When the 3D-PHONIC function or DOLBY DIGITAL function is operating, the "SUBWOOFER" item does not appear.
- This function cannot be cancelled even if you connect the headphones to the TV.

■ HEADPHONE

You need to use the HEADPHONE menu to adjust the volume of the headphones. The HEADPHONE menu can also be used to set whether or not sound is emitted from the TV speakers when the headphones are being used and to perform the settings for the sound emitted from the headphones.

- 1 Press the ▼/▲ buttons to choose **HEADPHONE**. Then press the **OK** button.

The sub-menu of the HEADPHONE function appears.

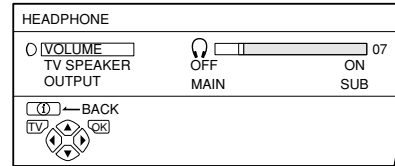

- 2 Press the ▼/▲ buttons to choose a function. Then press the ◀/▶ buttons to change the setting

VOLUME:

You can change the volume of the headphones.

TV SPEAKER:

You can turn the TV's speakers on or off.

ON:

The sound is emitted from the TV's speakers when using the headphones.

OFF:

The sound is not emitted from the TV's speakers when using the headphones.

- The sound from the external front speakers L/R and the subwoofer cannot be stopped even if you set the TV SPEAKER to OFF and connect the headphones to the TV. If you want to stop the sound from the external front speakers L/R and the subwoofer, please turn off all amplifiers connected to the TV.

OUTPUT

You can choose the sound output to the headphones.

MAIN:

You can listen to the sound of the main-picture with your headphones.

SUB:

You can listen to the sound of the sub-picture with your headphones.

- When a sub-picture is not displayed, the sound of the programme which is currently being viewed is output to the headphones irrespective of the OUTPUT setting.
- When a sub-picture is displayed, the sound of the sub-picture can be listened to with the headphones while listening to the sound of the main-picture with the TV speakers. In order to do this, set TV SPEAKER to ON and OUTPUT to SUB.

- 3 Press the **OK** button to complete the setting

The menu disappears.

DIGITAL SURROUND (Only AV32P10EK and AV32P10EI)

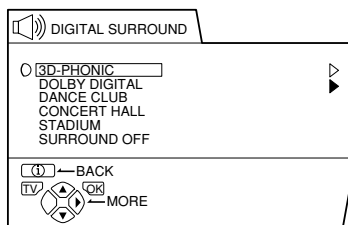

You can enjoy the surround sound with any of the five surround functions.

1 Press the OK button to display MENU (main menu)

2 Press the ▼/▲ buttons to choose DIGITAL SURROUND. Then press the OK button

The DIGITAL SURROUND menu is not displayed while the headphones are connected to the TV. Disconnect the headphones from the TV.

3 Press the ▼/▲ buttons to choose the function you want to use

To cancel a surround function:

Press the ▼/▲ buttons to choose SURROUND OFF.

4 Press the OK button to complete the setting

The menu disappears.

- When you connect the headphones, all surround functions will be cancelled.

■ 3D-PHONIC

Dolby Surround Pro Logic surround sound and Dolby Digital surround sound can be easily enjoyed without additional surround speakers.

Using rear surround signals of Dolby Surround encoded programmes or Dolby Digital programmes, this function will create the surround sound as if surround speakers were located to your right and left.

When viewing a programme from the EXT terminal which has been set to DIGITAL-IN:

You can enjoy the atmosphere of the surround sound of Dolby Digital programmes.

If the programme source has 5.1-channel Dolby Digital soundtracks, you can enjoy the atmosphere of the 5.1-channel Dolby Digital surround.

When viewing Dolby Surround encoded programmes, you can enjoy the atmosphere of Dolby Surround Pro Logic surround sound.

When viewing a programme from the EXT terminal which has not been set to DIGITAL-IN, or when viewing a TV broadcasting programme:

When viewing Dolby Surround encoded programmes, you can enjoy the atmosphere of Dolby Surround Pro Logic surround sound.

- You can turn this function on or off with a single press. For details, see “(4) 3D Button (Only AV32P10EK and AV32P10EI)” on page 12.
- For details of how to adjust the surround effect level, adjust the volume balance of the speakers, and perform the setting necessary when adding a front speaker system or subwoofer system, see “3D-PHONIC setting” on page 24.

- This function does not work properly except for Dolby Surround encoded programmes and Dolby Digital programmes.

■ DOLBY DIGITAL

You can enjoy the surround sound of Dolby* Digital programmes and Dolby Surround encoded programmes.

When viewing a programme from the EXT terminal which has been set to DIGITAL-IN:

You can enjoy the surround sound of Dolby Digital programmes.

If the programme source has 5.1-channel Dolby Digital soundtracks, you can enjoy the 5.1-channel Dolby Digital surround sound.

When viewing the Dolby Surround encoded programmes, you can enjoy the Dolby Surround Pro Logic surround sound.

When viewing a programme from the EXT terminal which has not been set to DIGITAL-IN, or when viewing a TV broadcasting programme:

When viewing the Dolby Surround encoded programmes, you can enjoy the Dolby Surround Pro Logic surround sound.

- Additional surround speakers are necessary in order to use this function to enjoy surround sound. Although you can listen to Dolby Digital audio without surround speakers, you cannot enjoy surround sound such as 5.1-channel Dolby Digital surround sound.
- Before using this function, correctly set each of the items in the DOLBY DIGITAL menu in accordance with “DOLBY DIGITAL setting” on page 24.
- Dolby Digital soundtracks can provide anything from mono to full 5.1-channel Dolby Digital surround sound. When a Dolby Digital audio signal is received, the number of front channels and rear channels included in the signal are displayed on the screen for a few seconds as “DOLBY D (number of front channels) / (number of rear channels)”. If LFE (low frequency effects) are included in the signal, “.1” is displayed after the number of rear channels. For example, “DOLBY D 3/2.1” is displayed when a 5.1-channel Dolby Digital signal is received.
- This function does not work properly except for Dolby Surround encoded programmes and Dolby Digital programmes.

** Manufactured under license from Dolby Laboratories. “Dolby”, “Pro Logic”, and the double-D symbol are trademarks of Dolby Laboratories. Confidential unpublished works. ©1992-1997 Dolby Laboratories. All rights reserved.*

- Dolby Digital is an advanced form of digital audio coding. Dolby Digital audio is available from programme sources (such as DVD-video discs) which are usually identified with a Dolby Digital logo.
- When you connect the subwoofer system to the TV, you can enjoy the powerful low frequency effects (LFE) of 5.1-channel Dolby Digital more effectively.
- This TV does not work with digital audio signals other than Dolby Digital audio. If no sound is emitted from the speakers, cancel the DIGITAL-IN setting and change to normal analog sounds.

Other surround functions

DANCE CLUB:

This function creates a dance club atmosphere.

CONCERT HALL:

This function creates a concert hall atmosphere.

STADIUM:

This function creates a stadium atmosphere.

- The above function does not appear in the DIGITAL SURROUND menu when viewing a programme from the EXT terminal which has been set to DIGITAL-IN.
- The above function does not work properly for the Dolby Surround encoded programmes or mono sound programmes.

3D-PHONIC setting

- 1 Press the **▼/▲** buttons to choose **3D-PHONIC**. Then press the **▶** button

The sub-menu of the 3D-PHONIC function appears.

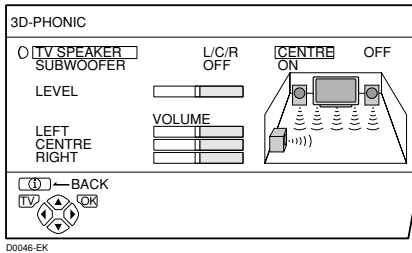

- 2 Press the **▼/▲** buttons to choose an item. Then press the **◀/▶** buttons to change the setting

TV SPEAKER:

Only set to CENTRE when the front speakers are connected to the TV. Otherwise set to L/C/R.

SUBWOOFER:

Set SUBWOOFER to ON when the subwoofer system is connected to the TV. Otherwise, set to OFF.

LEVEL:

You can control the effect level of the 3D-PHONIC function as you like.

VOLUME (LEFT/CENTRE/RIGHT):

You can adjust the sound level of each speaker individually. LEFT/RIGHT denotes left and right of the front speakers and CENTRE denotes the centre speaker.

- 3 Press the **OK** button to complete the setting

The menu disappears.

- When a speaker system is not connected to the TV, set TV SPEAKER to L/C/R and SUBWOOFER to OFF. Otherwise the sound will not be emitted correctly.
- When you do not want to hear sound from the TV speakers, set TV SPEAKER to OFF.
- If you set TV SPEAKER to CENTRE or OFF, the sound from the subwoofer can be heard only when listening to the Dolby Digital sound with the Low Frequency effect (LFE). If you want to hear sound from the subwoofer every time, set TV SPEAKER to L/C/R.

DOLBY DIGITAL setting

Correctly set the items in the sub-menu of the DOLBY DIGITAL function, and use the test signal to control the volume level of the speakers so that you can listen to the sounds from them uniformly. Be sure to do this before using the DOLBY DIGITAL function.

- 1 Press the **▼/▲** buttons to choose **DOLBY DIGITAL**. Then press the **▶** button

The sub-menu of the DOLBY DIGITAL function appears.

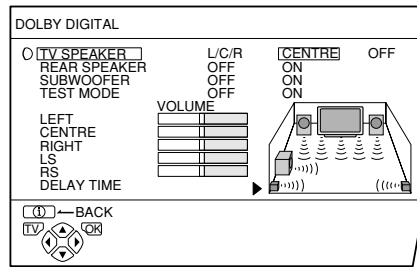

- 2 Press the **▼/▲** buttons to choose an item. Then press the **◀/▶** buttons to change the setting

TV SPEAKER:

Only set to CENTRE when the front speakers are connected to the TV. Otherwise set to L/C/R.

REAR SPEAKER:

Set to ON when the rear speaker is connected to the TV. Otherwise set to OFF. However, you cannot enjoy surround sound when it is set to OFF.

SUBWOOFER:

Set SUBWOOFER to ON when the subwoofer system is connected to the TV. Otherwise, set to OFF.

TEST MODE/VOLUME (LEFT/CENTRE/RIGHT/LS/RS):

Set the volume balance of the speakers so that the correct surround effect can be achieved.

When the other settings have been completed, adjust in accordance with "Adjusting the volume balance with the TEST MODE" on page 25.

DELAY TIME:

A delay can be applied to SURROUND (surround sound) and CENTRE (centre sound) depending on the arrangement of the speakers.

Select DELAY TIME and press the **▶** button to display the DELAY TIME menu. The DELAY TIME is changed in 1ms steps every time the **◀/▶** buttons are pressed.

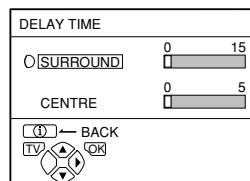

3 Press the OK button to complete the setting

The menu disappears.

- When a speaker system is not connected to the TV, set TV SPEAKER to L/C/R and SUBWOOFER to OFF. Otherwise the sound will not be emitted correctly.
- When you do not want to hear sound from the TV speakers, set TV SPEAKER to OFF.
- The CENTRE (centre sound) DELAY TIME cannot be adjusted when the TV SPEAKER is set to L/C/R.
- If you set TV SPEAKER to CENTRE or OFF, the sound from the subwoofer can be heard only when listening to the Dolby Digital sound with the Low Frequency effect (LFE). If you want to hear sound from the subwoofer every time, set TV SPEAKER to L/C/R.

Adjusting the volume balance with the TEST MODE

Use the test signal to adjust the volume level of each speaker so that they are all the same.

Preparation:

- The TV volume cannot be adjusted after the menu is displayed. Increase the TV volume level to about 10 before displaying the menu.

1 Display the sub-menu of the DOLBY DIGITAL function

2 Press the ▼/▲ buttons to choose TEST MODE. Then press the ◀/▶ buttons to choose ON

Test signals are output from each of the speakers in turn.

When using the front speaker system and/or subwoofer system with the TV:

Turn on the power of each amplifier, slowly increase the amplifiers' volumes until the sound emitted from each speaker connected to the system is about the same as that of the sound emitted from the TV speakers. Note that increasing the amplifier volume too high may damage the speakers.

Stopping the test signal:

Press the ▼/▲ buttons to choose TEST MODE and press the ◀/▶ buttons to choose OFF.

3 Press the ▼/▲ buttons to adjust the sound volume of each of the speakers.

Adjust the sound volumes so that you can listen to the sounds at the same volume when you are sitting where you would normally sit to watch the TV.

LEFT/RIGHT:

The left or right of the front speakers

CENTRE:

The centre speaker

LS/RS:

The left or right of the surround speakers

If REAR SPEAKER is set to OFF, LS and RS are not displayed.

4 Press the OK button to complete the settings

The menu disappears.

- When using the front speaker system or subwoofer system with the TV, it is recommended that this TEST MODE is used to adjust the speaker volume levels each time the system is used.

EXT SETTING

<AV32P10EK and AV32P10EI>

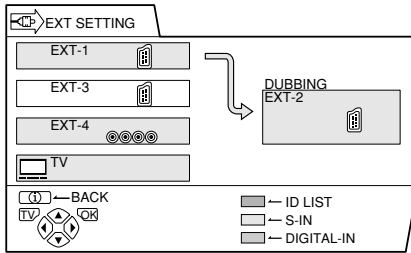

<AV32L5EK and AV32L5EI>

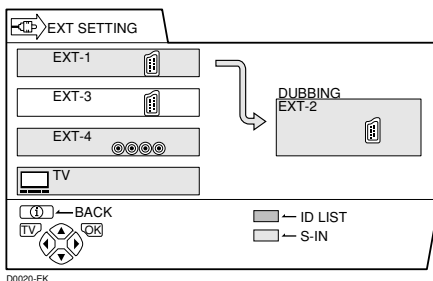

To display the EXT SETTING menu:

- 1 Press the **OK** button to display the **MENU** (main menu)
- 2 Press the **▼/▲** buttons to choose **EXT SETTING**. Then press the **OK** button

■ S-IN (S-VIDEO input)

You can connect a device (such as an S-VHS VCR) to enjoy the high-quality picture of the S-VIDEO signal (Y/C signal).

Preparation:

- First read the device's instruction manual and "Further preparation" on page 37 to connect the device to the TV properly. Second, follow the device's instruction manual to set the device so that it sends an S-VIDEO signal (Y/C signal) to the TV.
- Do not set S-IN (S-VIDEO input) to an EXT terminal connected to a device which cannot output an S-VIDEO (Y/C signal). If it is set wrongly, a picture cannot appear.

- 1 Press the **▼/▲** buttons or **◀/▶** buttons to choose an **EXT terminal**
- 2 Press the **yellow** button and set the **S-IN (S-VIDEO input)**

An **S** (S-VIDEO input) mark is displayed. You can view an S-VIDEO signal (Y/C signal) instead of the regular video signal (composite signal).

To cancel the S-IN (S-VIDEO input) setting:

Press the yellow button and turn off the **S** (S-VIDEO input) mark.

The regular video signal (composite signal) pictures are resumed.

3 Press the **OK** button to complete the setting.

The menu disappears.

- The EXT-1 terminal does not support S-VIDEO signal (Y/C signal) and you cannot set S-IN (S-VIDEO input) in the EXT-1 terminal.
- Setting S-IN (S-VIDEO input) changes the head character from "E" to "S". When an EXT terminal receives a normal video signal, "E1", "E2", "E3" or "E4" appears on the display. This changes to "S2", "S3" or "S4" when it receives an S-VIDEO signal.
- Even a device which can output an S-VIDEO signal (Y/C signal) may output a regular video signal (composite signal) depending on the device setting. If a picture cannot appear because the S-IN (S-VIDEO input) setting has been made, read the device instruction manual carefully again to check for the device settings.

■ DIGITAL-IN (Only AV32P10EK and AV32P10EI)

When connecting a device (such as a DVD player) which enables Dolby Digital audio signal to be output, you can listen to Dolby Digital audio.

Preparation:

- In order to listen to Dolby Digital audio, correctly connect a device to the TV in accordance with "Listening to Dolby Digital audio (Only AV32P10EK and AV32P10EI)" on page 38.
- If DIGITAL-IN is set by mistake when no device is connected to the DIGITAL AUDIO IN terminal, no sound is emitted.

- 1 Press the **▼/▲** buttons or **◀/▶** buttons to choose an **EXT terminal**
- 2 Press the **green** button to set the **DIGITAL-IN**

Pressing the green button repeatedly until the mark selected is the same as the type of cable connected to the DIGITAL AUDIO IN terminal.

⊙ : Select this mark when connected with coaxial cable.

Ⓛ : Select this mark when connected with optical cable.

To cancel the DIGITAL-IN setting:

Press the green button to turn off the mark of DIGITAL-IN.

3 Press the **OK** button to complete the setting

The menu disappears.

- DIGITAL-IN cannot be set for the TV and EXT-4 terminal.
- This TV does not work with digital audio signals other than Dolby Digital audio. If no sound is emitted from the speakers, cancel the DIGITAL-IN setting and change to normal analog sounds.

■ ID LIST

You can store a name for each of the devices connected to each EXT terminal. Giving a name to an EXT terminal makes the EXT terminal number appear on the screen, together with its name.

1 Press the ▼/▲ buttons or ◀/▶ buttons to choose an EXT terminal

2 Press the blue button to display the name list (ID LIST)

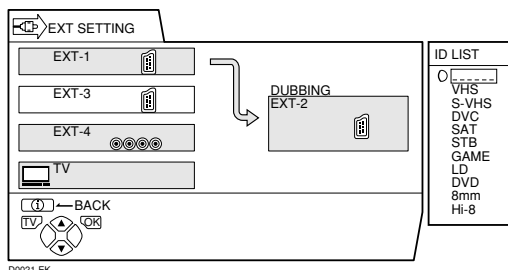

3 Press the ▼/▲ buttons to choose a name. Then press the OK button.

The ID LIST disappears and the name is assigned to the EXT terminal.

To erase a name assigned to the EXT terminal:

Choose a blank space.

4 Press the OK button to complete the setting.

The menu disappears.

- You cannot choose an EXT terminal name that is not on the name list (ID LIST).

■ DUBBING

You can choose a signal source to be output from the EXT-2 terminal.

You can do this with the output signal of the device connected to another EXT terminal, or the picture and sound from a TV channel you are currently viewing.

1 Press the ◀/▶ buttons to choose the arrow from the menu.

2 Press the ▼/▲ buttons to choose another EXT terminal or TV.

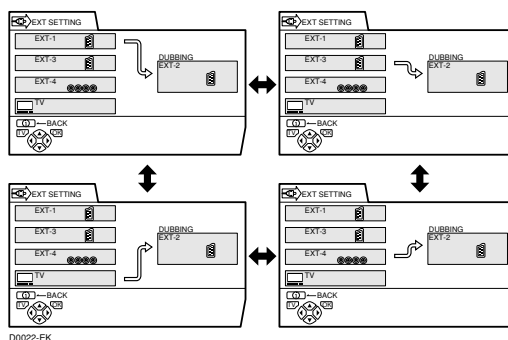

The arrow in the menu represents a signal flow. The left side of the arrow shows a signal source output from the EXT-2 terminal.

EXT-1/EXT-3/EXT-4:

The output signal of the device connected to an EXT terminal passes through the TV and is output from the EXT-2 terminal.

TV:

The picture and sound of the TV channel you are currently viewing are output from the EXT-2 terminal.

3 Press the OK button to complete the setting.

The menu disappears.

- During dubbing, you should not turn off the TV. Turning off the TV also turns off the output from the EXT-2 terminal.
- When you choose an EXT terminal as an output, you can view a TV programme or a picture from the other EXT terminal while dubbing the picture from a device connected to the EXT terminal onto a VCR connected to the EXT-2 terminal.
- The RGB signals from TV games cannot be output.
- Teletext programmes cannot be output.
- The sub-picture displayed by the PIP function cannot be output.
- The still picture displayed by the FREEZE function cannot be output.
- The sound from the EXT terminal set to DIGITAL-IN cannot be output. (Only AV32P10EK and AV32P10EI)

FEATURES

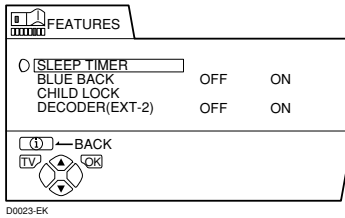

To display the FEATURES menu:

- 1 Press the **OK** button to display the MENU (main menu)
- 2 Press the **▼/▲** buttons to choose **FEATURES**. Then press the **OK** button

■ SLEEP TIMER

You can set the TV to automatically turn off after a set time.

- 1 Press the **▼/▲** buttons to choose **SLEEP TIMER**. Then press the **OK** button

A sub-menu of the SLEEP TIMER function appears.

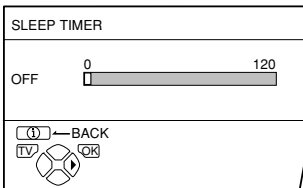

- 2 Press the **◀/▶** buttons to set the period of time

You can set the time for up to 120 minutes (2 hours) in 10 minute steps.

To cancel the SLEEP TIMER function:

Press the **◀** button to set the period of time to "OFF."

- 3 Press the **OK** button to complete the setting

The menu disappears.

- One minute before the SLEEP TIMER function turns off the TV, "GOOD NIGHT!" appears.
- The SLEEP TIMER function cannot be used to turn off the TV's main power.
- When the SLEEP TIMER function is on, you can display the sub-menu of the SLEEP TIMER function again to confirm or change the remaining period of time of the SLEEP TIMER function. Press the **OK** button to leave the menu after confirming or changing the remaining time.

■ BLUE BACK

You can set the TV to automatically change to a blue screen and mute the sound if the signal is weak or absent, or when there is no input from an external device.

- 1 Press the **▼/▲** buttons to choose **BLUE BACK**
- 2 Press the **◀/▶** buttons to choose **ON**

To cancel the BLUE BACK function:

Press the **◀/▶** buttons to choose OFF.

- 3 Press the **OK** button to complete the setting

The menu disappears.

■ CHILD LOCK

When there is a TV channel you do not want your children to watch, you can use the CHILD LOCK function to lock out the TV channel. Even when a child chooses a programme number (PR) for a locked TV channel the screen will change to blue and display  (CHILD LOCK) so the TV channel cannot be viewed. Unless you enter a pre-set ID number by a special operation, the lock cannot be released and the child cannot view the TV channel.

To set the CHILD LOCK function

- 1 Press the **▼/▲** buttons to choose **CHILD LOCK**. Then press the **0 (AV)** button.

"SET ID NO." (ID number setting screen) appears.

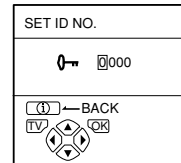

- 2 To set the ID number you want

- 1 Press the **▼/▲** buttons to choose a number
- 2 Press the **◀/▶** buttons to move the cursor

- 3 Press the **OK** button.

The sub-menu of CHILD LOCK appears.

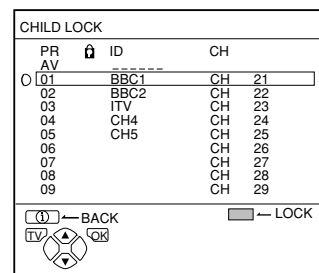

- 4 Press the **▼/▲** buttons to choose a TV channel

Every time you press the **▼/▲** buttons, the programme number (PR) changes, and the picture of the TV channel registered in the programme number (PR) is displayed on the screen.

5 Press the blue button and set the CHILD LOCK function

 (CHILD LOCK) appears and the TV channel is locked.

To reset the CHILD LOCK function:

Press the blue button again.

 (CHILD LOCK) disappears.

6 Press the OK button to complete the setting

The menu disappears.

- To disable easy resetting of the CHILD LOCK function, the menu disappears if you choose the CHILD LOCK function and press the **OK** button.

To view a locked TV channel

1 Choose a programme number (PR) for a locked TV channel, by using the number buttons or PR LIST

The screen changes to blue and the  (CHILD LOCK) appears. You cannot view the TV channel.

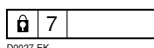

2 Press the (information) button to display "ID NO." (ID NO. input screen)

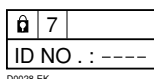

3 Press the number buttons to enter the ID number

The lock is temporarily released so you can view the TV channel.

If you have forgotten the ID number:

Perform step 1 of "To set the CHILD LOCK function". After confirming the ID number, press the **TV** button to exit the menu.

- Even if you reset the lock temporarily, it does not mean that the CHILD LOCK function set for the TV channel is cancelled. The next time anyone tries to view the TV channel, it will be locked again.
- When you want to cancel the CHILD LOCK function, you must perform the operation "To set the CHILD LOCK function" again.
- To stop it being easy to choose the programme number (PR) of a locked TV channel, the programme number (PR) has been set so that it cannot be chosen by the **▼/▲** buttons or the buttons of the TV.
- To stop it being easy to reset the lock, "ID NO." (ID NO. input screen) is set so that it cannot appear unless you press the  (Information) button.

■ DECODER (EXT-2)

You can only use this function if you have a decoder connected to a T-V LINK compatible VCR, which in turn is connected to the EXT-2 terminal. To use this function, see "Using the DECODER (EXT-2) function" on page 35.

- If you have not connected a decoder with a T-V LINK compatible VCR to the EXT-2 terminal, setting this function to "ON" by mistake causes the picture/sound of a TV channel you are currently viewing to disappear.

INSTALL

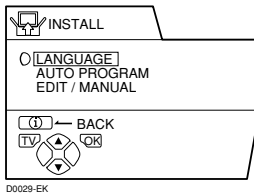

To display the **INSTALL** menu:

- 1 Press the **OK** button to display the **MENU** (main menu)
- 2 Press the **▼/▲** buttons to choose the **INSTALL** menu. Then press the **OK** button

LANGUAGE

You can choose the language you want to use for the on-screen display from the language list in the menu.

- 1 Press the **▼/▲** buttons to choose **LANGUAGE**. Then press the **OK** button

A sub-menu of the **LANGUAGE** function appears.

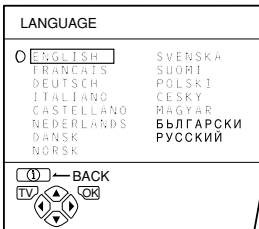

- 2 Press the **◀/▶** and **▼/▲** buttons to choose a language
- 3 Press the **OK** button to complete the setting

The menu disappears.

AUTO PROGRAM

You can automatically store the TV channels for which you have the best reception. Store them in the TV's programme numbers (PR) list by doing the following.

- 1 Press the **▼/▲** buttons to choose **AUTO PROGRAM**
- 2 Press the **OK** button to start the **AUTO PROGRAM** function

The **AUTO PROGRAM** menu appears and the TV channels you receive are automatically registered in the programme numbers (PR) list.

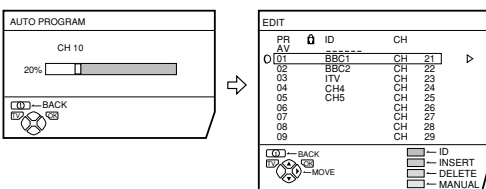

D0004-EK

If **“ACI START/ACI SKIP”** appears in the **AUTO PROGRAM** menu:

You can use the **ACI** (Automatic Channel Installation) function to decode the **ACI** data and complete the registration of all the TV channels quickly. For details of the **ACI** function and how to use it, see “Using the **ACI** function” on page 35.

If you don't want to use the **ACI** function, press the **▼/▲** button to choose **ACI SKIP** and then press **OK**.

To cancel the **AUTO PROGRAM** function:

Press the **TV** button.

- 3 After the TV channels have been stored in the programme numbers (PR) list, the **EDIT** menu appears

You can now edit the programme numbers (PR) list using the **EDIT/MANUAL** function. For details, see “**EDIT/MANUAL**” on page 31.

When not using the **EDIT/MANUAL** function:

If you do not need to use the **EDIT/MANUAL** function, go to the next step.

- 4 Press the **OK** button to display the **T-V LINK** menu

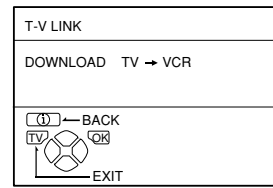

D0005-EK

- 5 Operate the **T-V LINK** menu according to the type of video cassette recorder (VCR) you have connected to the **EXT-2** terminal

If you do not have a **T-V LINK** compatible VCR connected:

Press the **TV** button to leave the **T-V LINK** menu.

The **T-V LINK** menu disappears, and all the settings are completed.

If you have a **T-V LINK** compatible VCR connected:

See “Downloading data to a VCR” on page 35 to transmit the programme number (PR) data to the VCR.

- If a TV channel you want to view is not set to a programme number (PR), set it manually using the **MANUAL** function. For details, see “**EDIT/MANUAL**” on page 31.
- The **AUTO PROGRAM** function does not set the programme number **PR 0** (AV) for your video cassette recorder. You will need to set this using the manual function.
- In some areas you may get TV reception from more than one transmitter, for example different **ITV** regions. In this case each TV channel could be set twice. If this happens, the first set of channels will have the stronger signal. If you want to delete the second set of channels, you will have to do it manually (see page 33).

■ EDIT/MANUAL

The EDIT/MANUAL functions are divided into two types:

- editing the current programme numbers (PR) (EDIT functions); and
- manually storing a TV channel you want to view as a programme number (PR) (MANUAL function).

Here are the details about these functions:

MOVE:

This function changes the programme number (PR) of a TV channel.

ID:

This function registers a channel name (ID) to a TV channel.

INSERT:

This function adds a new TV channel in the current programme numbers (PR) list by using the CH/CC number.

DELETE:

This function deletes a TV channel you do not want to list.

MANUAL:

This function manually stores a new TV channel in a programme number (PR).

- For programme number PR 0, "AV" appears in the programme numbers (PR) list.
- An EXT terminal number does not appear in the programme numbers (PR) list.
- The CH/CC number is a number unique to the TV and corresponds to the channel number of a TV channel. For the relationship between a channel number and a CH/CC number, see "CH/CC NUMBER" on page 33.
- You cannot use the INSERT function if you do not know the channel number of a TV channel. Use the MANUAL function to register a TV channel in the programme number (PR) list.

Caution:

- Using the MOVE, DELETE or INSERT functions rewrites the current programme numbers (PR) list. Therefore, the programme numbers (PR) of some of the TV channels will change.
- Using the MANUAL function for a TV channel for which the CHILD LOCK function has been set cancels the CHILD LOCK function for that channel.
- Using the MANUAL function for a TV channel for which the DECODER (EXT-2) function has been set to ON returns the setting of the DECODER (EXT-2) function for that channel to OFF.
- When a TV channel has already been registered in PR 99, using the INSERT function deletes that TV channel.

1 Press the ▼/▲ buttons to choose EDIT/MANUAL. Then press the OK button

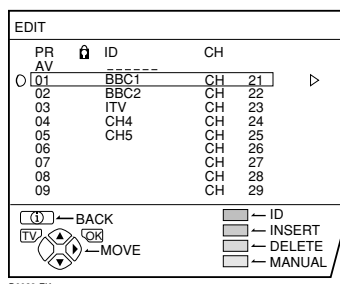

2 Follow the options for the function you want to use

3 Press the OK button to complete the settings

The T-V LINK menu appears.

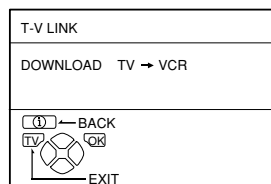

4 Follow the T-V LINK menu according to the type of VCR you have connected to the EXT-2 terminal

If you do not have a T-V LINK compatible VCR connected:

Press the TV button to leave the T-V LINK menu.

The T-V LINK menu disappears and all the settings are completed.

If you have a T-V LINK compatible VCR connected:

Follow the operating procedure "Downloading data to a VCR" on page 35 to transmit the programme number (PR) data to the VCR.

MOVE

1 Press the ▼/▲ buttons to choose a TV channel

Every time you press the ▼/▲ buttons, the programme number (PR) changes, and the picture of the TV channel stored in the programme number (PR) appears on the screen.

2 Press the ► button to start the MOVE function

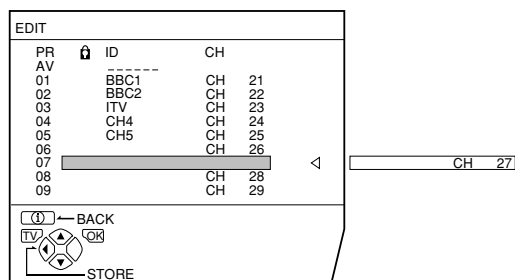

3 Press the ▼/▲ buttons to choose a new programme number (PR)

To cancel the MOVE function:

Press the (i) (information) button.

4 Press the ◀ button to change the programme number (PR) of a TV channel to a new programme number (PR)

ID

1 Press the ▼/▲ buttons to choose a TV channel

Every time you press the ▼/▲ buttons, the programme number (PR) changes, and the picture of the TV channel stored in the programme number (PR) appears on the screen.

2 Press the red button to start the ID function

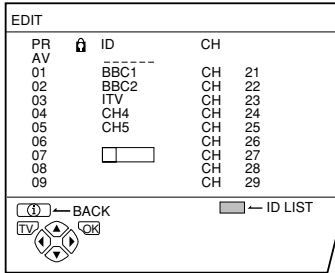

D0001-EK

3 Press the ▼/▲ buttons to choose the first character of a channel name (ID) you want to give the TV channel

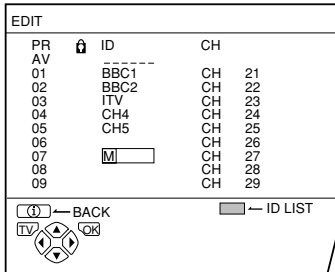

D0002-EK

4 Press the blue button to display the ID LIST (channel name list)

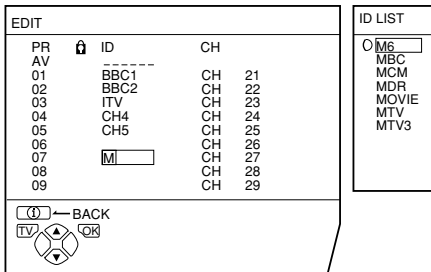

D0003-EK

5 Press the ▼/▲ buttons to choose the channel name (ID)

To cancel the ID function:

Press the **i** (Information) button.

6 Press the OK button to give a channel name (ID) to a TV channel

- You can give your own unique channel name (ID) to the TV channel. When you have finished step 3, do not go to step 4. Press the ◀/▶ buttons to move the cursor, and press the ▼/▲ buttons to choose each character of the channel name (ID). Then press the **OK** button to register the channel name (ID) to the TV channel.

INSERT

Preparation:

- You need to find the CH/CC number for the TV channel. Find the CH/CC number from the “CH/CC NUMBER” table on page 33 based on the channel number of the TV channel.

1 Press the ▼/▲ buttons to choose a Programme number (PR) for which you will register a new TV channel

2 Press the green button and start the INSERT function

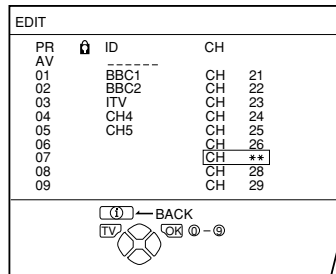

D0004-EK

To cancel the INSERT function:

Press the **i** (Information) button.

3 For UK model (AV32P10EK/AV32L5EK):

Press the number buttons to enter the remaining CH number.

- You cannot enter CC numbers.

For Ireland model (AV32P10EI/AV32L5EI):

Press the ▼/▲ buttons to choose “CH” or “CC”, then enter the remaining CH or CC number.

The TV shifts to registration mode.

When the registration is completed, the picture of the TV channel appears on the screen.

- The CH/CC number is a number given to each broadcast frequency that carries a TV channel. If the TV cannot detect the TV channel corresponding to the broadcast frequency indicated by the CH/CC number, a “no-signal” picture appears.

DELETE

1 Press the ▼/▲ buttons to choose a TV channel

Every time you press the ▼/▲ buttons, the programme number (PR) changes over, and the picture of the TV channel stored in the programme number list (PR) appears on the screen.

2 Press the yellow button to delete the TV channel

The TV channel is deleted from the programme numbers (PR) list.

MANUAL

1 Press the ▼/▲ buttons to choose a programme number (PR) for a new TV channel

2 Press the blue button to activate the MANUAL function

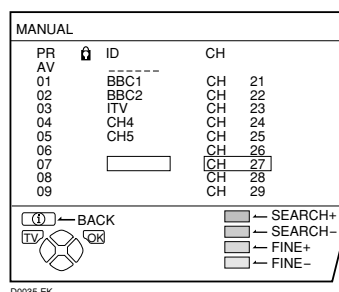

To cancel the MANUAL function:

Press the ⓘ (Information) button.

3 Press the green or red button to search for a TV channel

Scanning stops when the TV finds a TV channel. Then the TV channel is displayed.

4 Press the green or red button repeatedly until the TV channel you want appears

If the TV channel reception is poor:

Press the blue or yellow button to fine-tune the TV channel.

5 Press the OK button and register the TV channel to a programme number (PR)

The normal EDIT menu appears.

CH/CC NUMBER

- When you want to use the INSERT function on page 32, find the CH/CC number corresponding to the channel number of the TV channel from this table. If you want to know a particular TV channel's channel menu, look in TV listings magazines or contact the broadcaster.
- The UK model (AV32P10EK/AV32L5EK) cannot receive the CC number channels or the channels from CH 02 to CH 12.

CH	Channel
CH 02	E2, IR A
CH 03	E3, IR B, ITALY A
CH 04	E4, IR C, ITALY B
CH 05	E5, IR D, ITALY D
CH 06	E6, IR E, ITALY E
CH 07	E7, IR F, ITALY F
CH 08	E8, IR G
CH 09	E9, ITALY G
CH 10	E10, IR H, ITALY H
CH 11	E11, IR J, ITALY H+1
CH 12	E12, ITALY H+2
CH 21	E21
CH 22	E22
CH 23	E23
CH 24	E24
CH 25	E25
CH 26	E26
CH 27	E27
CH 28	E28
CH 29	E29
CH 30	E30
CH 31	E31
CH 32	E32
CH 33	E33
CH 34	E34
CH 35	E35
CH 36	E36
CH 37	E37
CH 38	E38
CH 39	E39

CH	Channel
CH 40	E40
CH 41	E41
CH 42	E42
CH 43	E43
CH 44	E44
CH 45	E45
CH 46	E46
CH 47	E47
CH 48	E48
CH 49	E49
CH 50	E50
CH 51	E51
CH 52	E52
CH 53	E53
CH 54	E54
CH 55	E55
CH 56	E56
CH 57	E57
CH 58	E58
CH 59	E59
CH 60	E60
CH 61	E61
CH 62	E62
CH 63	E63
CH 64	E64
CH 65	E65
CH 66	E66
CH 67	E67
CH 68	E68
CH 69	E69

CC	Channel
CC 01	S1
CC 02	S2
CC 03	S3
CC 04	S4
CC 05	S5
CC 06	S6
CC 07	S7
CC 08	S8
CC 09	S9
CC 10	S10
CC 11	S11
CC 12	S12
CC 13	S13
CC 14	S14
CC 15	S15
CC 16	S16
CC 17	S17
CC 18	S18
CC 19	S19
CC 20	S20
CC 21	S21
CC 22	S22
CC 23	S23
CC 24	S24
CC 25	S25
CC 26	S26
CC 27	S27
CC 28	S28
CC 29	S29
CC 30	S30

CC	Channel
CC 31	S31
CC 32	S32
CC 33	S33
CC 34	S34
CC 35	S35
CC 36	S36
CC 37	S37
CC 38	S38
CC 39	S39
CC 40	S40
CC 41	S41
CC 75	X
CC 76	Y
CC 77	Z, ITALY C
CC 78	Z+1
CC 79	Z+2

DEMO

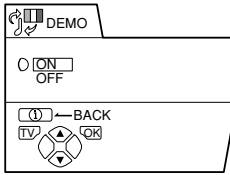

To display the DEMO menu:

- 1 Press the **OK** button to display the **MENU** (main menu)
- 2 Press the **▼/▲** buttons to choose **DEMO**. Then press the **OK** button

The DEMO function automatically demonstrates some of the TV functions.

- 1 Press the **▼/▲** buttons to choose **ON**
- 2 Press the **OK** button to complete the setting

The DEMO function is set to ON, and the demonstration will start.

To stop the demonstration:

Press one of the buttons on the remote control.

When the DEMO function is set to ON:

Each time the TV is turned on, the demonstration starts automatically. If you do not want that to happen, cancel the DEMO function:

- 1 Display the **DEMO** menu again
- 2 Press the **▼/▲** buttons to choose **OFF**
- 3 Press the **OK** button to cancel the **DEMO** function

Other menus

■ Using the ACI function

This TV has an ACI function which decodes the ACI (automatic channel installation) data.

Using the ACI function allows all TV channels transmitted from the cable TV station to be properly registered quickly, using the data from the cable TV station.

Caution:

If your cable TV station broadcasts ACI data and if "ACI START/ACI SKIP" appears in the AUTO PROGRAM menu, the ACI function is enabled. In all other cases, it is disabled.

1 Press the ▼/▲ button to choose ACI START. Then press the OK button to start the ACI function

When you don't want to use the ACI function:

Press the ▼/▲ button to choose ACI SKIP and then press the OK button.

If the AUTO PROGRAM menu changes to another menu:

Depending on your cable TV station, there may be a broadcast selection menu set up by the cable TV station. Follow the menu instructions and use the ◀/▶ and ▼/▲ buttons to operate the menu. After you have made the setting, press the OK button.

If "ACI ERROR" is displayed in the AUTO PROGRAM menu:

"ACI ERROR" means that the ACI function is not working properly. Press the OK button to start the ACI function again.

If "ACI ERROR" still appears even after you have tried to start the ACI function several times, press the ► button to start the AUTO PROGRAM function. It does not cause any problems because all the TV channels are registered to the programme numbers (PR) by the AUTO PROGRAM function.

2 When the settings are completed, the EDIT menu is displayed. Return to the instructions that you were reading before, and continue

When the "Initial Settings" have been made:

Return to step 5 of "Initial settings" on page 6

When the "AUTO PROGRAM" has been made:

Return to step 3 of "AUTO PROGRAM" on page 30

- If you have any questions about the items in the cable TV station's broadcast selection menu or how to operate the menu, please contact your cable TV station.
- When the cable TV broadcast reception is poor, the ACI function will not work properly.
- If there is an error in the ACI data itself, the TV channel cannot be registered properly. If this happens, turn the ACI function off (ACI SKIP) and use the AUTO PROGRAM function, or the EDIT/MANUAL function to correct the programme number (PR) setting.

■ Downloading data to a VCR

You can send the latest programme numbers (PR) data to a VCR with the T-V LINK function.

- You can only do this when a T-V LINK compatible VCR is connected to the EXT-2 terminal.
- This only works when the T-V LINK menu is being displayed.

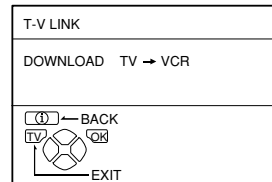

1 Turn on the VCR

2 Press the OK button

The data transmission begins.

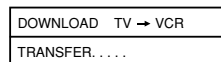

The T-V LINK menu disappears once the data transmission ends.

When the T-V LINK menu changes over to another menu:

The TV has finished its menu. This new menu is operated from the VCR. See the VCR instruction manual for what to do next.

- If "FEATURE NOT AVAILABLE" appears at the T-V LINK menu, check the following three items. Then press the OK button to retry data transmission.
 - Has a T-V LINK compatible VCR been connected to the EXT-2 terminal?
 - Has the VCR power been turned on?
 - Does the SCART cable that connects the EXT-2 terminal to the T-V LINK compatible VCR have all its proper connections?

■ Using the DECODER (EXT-2) function

If you have a decoder connected to a T-V LINK compatible VCR, which in turn is connected to the EXT-2 terminal, use the DECODER (EXT-2) function to unscramble the scrambled TV channels.

1 Turn on the decoder power

2 Display the scrambled TV channel on the TV

Even if the decoder is working, a scrambled picture appears.

3 Press the OK button to display the MENU

The MENU (main menu) appears.

4 Press the ▼/▲ buttons to choose FEATURES. Then press the OK button.

The FEATURES menu appears.

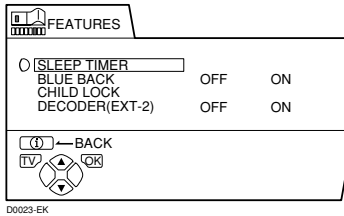

D0023-EK

5 Press the ▼/▲ buttons to choose DECODER (EXT-2) . Then press the ◀/▶ buttons to choose ON

An unscrambled picture appears.

To cancel the DECODER (EXT-2) function:

Press the ◀/▶ buttons to choose OFF.

6 Press the OK button to complete the setting

The T-V LINK menu appears.

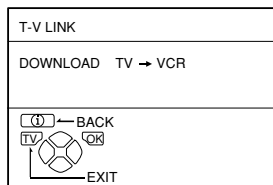

D0005-EK

7 Follow “Downloading data to a VCR” on page 35 to transmit the programme number (PR) data to the VCR

8 If you have another TV channel you want to unscramble using a decoder, repeat steps 2 to 7.

- If the DECODER (EXT-2) function has been set to “ON” but the TV channel cannot be unscrambled, check the following:
 - Has the decoder been connected to the VCR properly according to the VCR and decoder instruction manuals?
 - Has the decoder power been turned on?
 - Can the TV channel be unscrambled with a decoder?
 - Do you need to change the VCR settings in order to connect the decoder? Confirm that the VCR is set properly by rechecking the VCR Instruction manual.

Further preparation

■ Connecting external equipment

Connect the equipment to the TV, making the correct rear panel and front panel connections.

Before connecting anything:

- Read the manuals that came with the equipment.
Depending on the equipment, the connection method may be different from the diagram. Also, the equipment settings may need to change depending on the connection method.
- Turn off all the equipment including the TV.
- The “Specifications” on page 43 and the back cover give the details of the EXT terminals. If you are connecting equipment not listed in the following connection diagram, see the table to choose the best EXT terminal.
- Connecting cables are not supplied.

- ① VCR (composite signal)
- ② VCR (composite signal/S-VIDEO signal)
- ③ T-V LINK compatible VCR (composite signal/S-VIDEO signal)
- ④ Decoder
- ⑤ DVD player (composite signal/S-VIDEO signal)
- ⑥ DVD player (composite signal/RGB signal)
- ⑦ TV game (composite signal/RGB signal)
- ⑧ TV game (composite signal/S-VIDEO signal)
- ⑨ Headphones
- ⑩ Camcorder (composite signal/S-VIDEO signal)
- ⑪ SCART cable
- ⑫ Audio cable
- ⑬ Video cable
- ⑭ S-VIDEO cable

<AV32P10EK and AV32P10EI> Behind the Cover

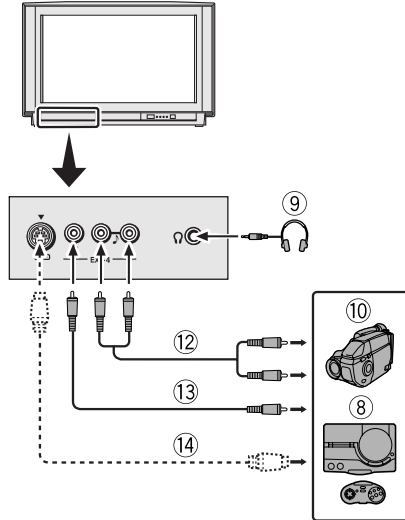

<AV32L5EK and AV32L5EI> Side of the TV

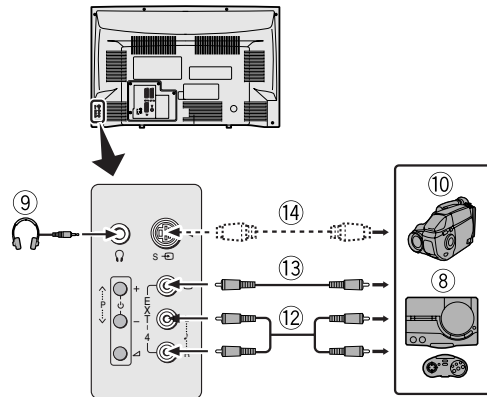

Back of the TV

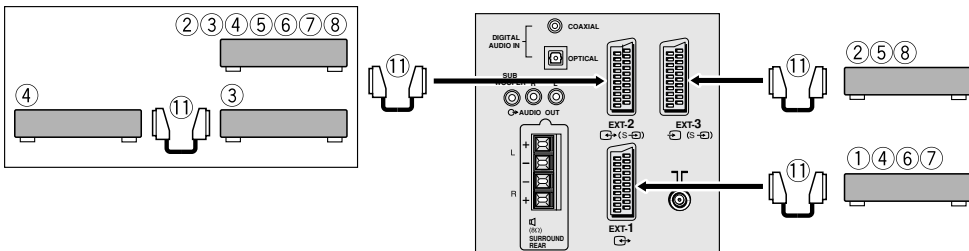

Equipment which can output the S-VIDEO signal (Y/C signal) such as an S-VHS VCR

Connect the equipment to an EXT terminal (but not the EXT-1 terminal).

You can choose between an S-VIDEO signal (Y/C signal) and a regular video signal (composite signal). For details of how to operate the equipment, see "S-IN (S-VIDEO input)" on page 26.

T-V LINK compatible VCR

Be sure to connect the T-V LINK compatible VCR to the EXT-2 terminal. If not, the T-V LINK function will not work properly.

- When connecting a T-V LINK compatible VCR to the EXT-2 terminal, be sure to connect the decoder to the VCR. If not, the T-V LINK function may not work properly. After you have stored TV channels in the programme numbers (PR) list, set the DECODER (EXT-2) function for the programme number (PR) to ON to unscramble a scrambled TV channel. For details, see "Using the DECODER (EXT-2) function" on page 35.

Connecting headphones

Connect the headphones with a stereo mini-jack (3.5mm diameter) to the headphone jack at the TV front panel.

Video or sound signal output from the EXT-2 terminal

You can change over the output of the video/sound signal from the EXT-2 terminal. This is useful when you want to dub the video/sound from another device onto the VCR connected to the EXT-2 terminal. For details on how to do this, see "DUBBING" on page 27.

TV output from the EXT-1 terminal

The video/sound signal of a TV channel you are viewing is always output from the EXT-1 terminal.

- Changing over a programme number (PR) also changes over the TV output from the EXT-1 terminal.
- The video/sound signal from an EXT terminal cannot be output.
- Teletext programmes cannot be output.

■ Listening to Dolby Digital audio (Only AV32P10EK and AV32P10EI)

In order to listen to Dolby Digital audio which is recorded as a Dolby Digital programme source (such as a DVD-video disc), connect the device and set the DIGITAL-IN as described below.

Preparation:

- A device (such as DVD player) with a digital output terminal (coaxial or optical) for Dolby Digital is necessary.
- A coaxial cable or optical cable is necessary to make the connections. (Not supplied with the TV)
- In accordance with the instruction manual which is supplied with the device, correctly connect a coaxial cable or optical cable to the device's DIGITAL OUT (digital output) terminal and set the device so that the Dolby Digital audio signal is output.
- Correctly connect the device to the EXT terminal in accordance with "Connecting external equipment" on page 37. However, since the EXT-4 terminal does not work with Dolby Digital audio, it cannot be used.

- 1 Connect the device to the DIGITAL AUDIO IN terminal with a coaxial cable **1** or optical cable **2**

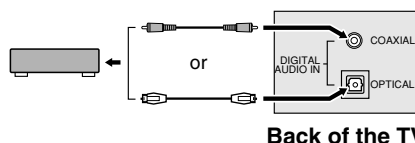

- 2 Connect the device and set the EXT terminal to DIGITAL-IN in accordance with "DIGITAL-IN (Only AV32P10EK and AV32P10EI)" on page 26

This completes the preparation.

- When an optical input and coaxial input are input simultaneously, the optical input takes precedence.
- When the headphones are used, the sound becomes normal stereo.
- This TV does not work with digital audio signals other than Dolby Digital audio. If no sound is emitted from the speakers, cancel the DIGITAL-IN setting and change to normal analog sound.
- The sound from the EXT terminal set to DIGITAL-IN is not output from the EXT-2 terminal.

■ Using additional audio equipment

After correctly connecting the audio equipment to the TV, use the TV menu to correctly set the functions of the audio equipment.

1 Connect the audio equipment to the TV.

Before connecting anything:

- Read the manuals that came with the audio equipment.
- Do not turn the power of the TV or audio equipment on until the connections have been completed.
- If the additional speakers are placed immediately next to the TV, use magnetic-shielded speakers in order to prevent magnetism from the speakers adversely affecting the TV.
- Connecting cables are not supplied.
- The sound from the external front speakers L/R and the subwoofer cannot be stopped even if you set the TV SPEAKER function in the HEADPHONE menu to OFF and connect the headphones to the TV. If you want to stop the sound from the external front speakers L/R and the subwoofer, please turn off all amplifiers connected to the TV.

Surround speakers **1** (Only AV32P10EK and AV32P10EI):

Connect surround speakers to the TV when you want to use the DOLBY DIGITAL function to enjoy surround sound.

- Even without surround speakers, you can easily enjoy surround sound by using the 3D-PHONIC function.
- Use impedance 8-ohm type.
- Pay attention to the positive (+) and negative (-) polarities when connecting surround speakers to your TV.
- For the best effect, position the surround speakers at least 1 metre above the heads of seated viewers.

Front speaker system

(Front L/R speakers **2** and amplifier **3**):

You can use your hi-fi audio system speakers instead of the TV speakers.

Subwoofer system

(Subwoofer **4** and amplifier **5**) (Only AV32P10EK and AV32P10EI):

Using the subwoofer system improves the playing performance of low sounds.

- It is particularly effective with the low frequency effects (LFE) included in 5.1-channel Dolby Digital surround sound.

<AV32L5EK/AV32L5EI>

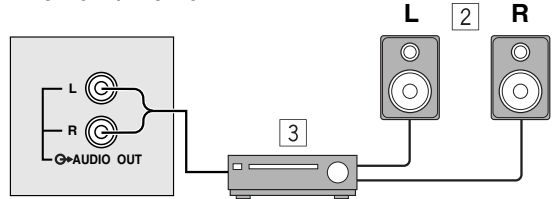

Back of the TV

<AV32P10EK/AV32P10EI>

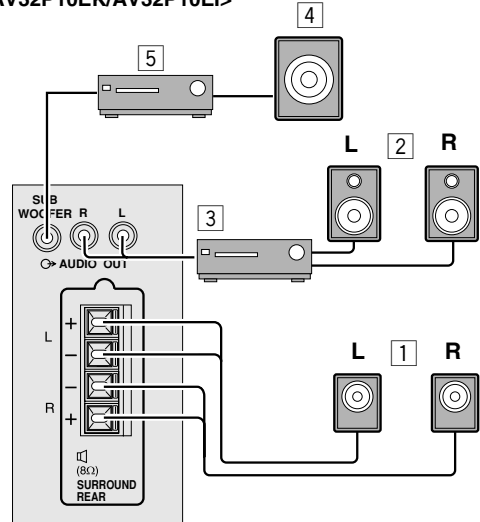

Back of the TV

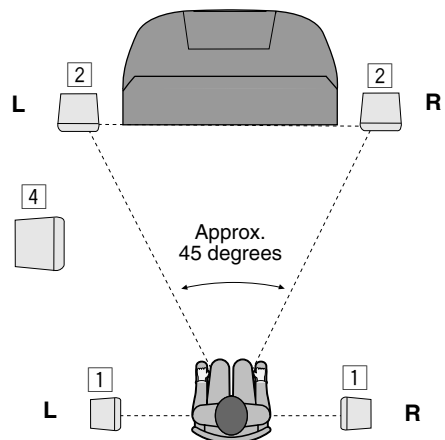
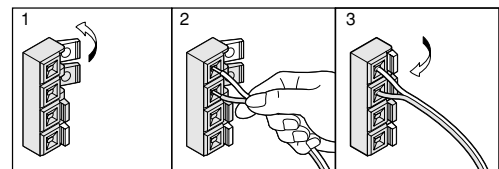

Positioning of speakers

2 Set the following functions (A to D) correctly depending on the speakers you want to use

A: SPEAKER function

Stop the sound from being emitted from the TV speakers.

Correctly perform the settings in accordance with "SPEAKER" on page 21.

B: TV SPEAKER function (Only AV32P10EK and AV32P10EI)

When using the 3D-PHONIC function or DOLBY DIGITAL function, all the TV speakers work as centre speakers.

Correctly perform the settings in accordance with "3D-PHONIC setting" on page 24 and "DOLBY DIGITAL setting" on page 24.

- Note that the function explained here is different to the TV SPEAKER function in the HEADPHONE menu.
- When the TV SPEAKER function in either one of the 3D-PHONIC menu or DOLBY DIGITAL menu is set, the other is automatically set.

C: SUBWOOFER function (Only AV32P10EK and AV32P10EI)

When using the 3D-PHONIC function or the DOLBY DIGITAL function, the SUBWOOFER function makes the low frequency effects (LFE) included in 5.1-channel Dolby Digital surround sound more effective.

Correctly perform the settings in accordance with "SUBWOOFER (Only AV32P10EK and AV32P10EI)" on page 22, "3D-PHONIC setting" on page 24 and "DOLBY DIGITAL setting" on page 24.

- When the SUBWOOFER function in any one of the SOUND SETTING menu, 3D-PHONIC menu or DOLBY DIGITAL menu is set, the others are automatically set.
- If you set TV SPEAKER (B) to CENTRE or OFF, the sound from the subwoofer can be heard only when listening to the Dolby Digital sound with the Low Frequency effect (LFE).
If you want to hear sound from the subwoofer every time, set TV SPEAKER to L/C/R.

D: REAR SPEAKER function (Only AV32P10EK and AV32P10EI)

When the DOLBY DIGITAL function is used Dolby Digital programme surround sound is emitted from the surround speakers.

Correctly perform the settings in accordance with "DOLBY DIGITAL setting" on page 24.

- Note that you cannot use the DOLBY DIGITAL function to enjoy surround sound if the REAR SPEAKER function is turned OFF.

Do you use the front speaker system?

	A	B (Only AV32P10EK and AV32P10EI)
Yes	OFF	CENTRE
No	ON	L/C/R

- In cases where you do not want to hear sound from the TV speakers set B (TV SPEAKER) to OFF.

Do you use the subwoofer system? (Only AV32P10EK and AV32P10EI)

	C
Yes	ON
No	OFF

Do you use the surround speakers? (Only AV32P10EK and AV32P10EI)

	D
Yes	ON
No	OFF

- By using the ◀/▶ buttons on the TV remote control or the buttons on the TV, the volume of all the speakers including those of the additional audio equipments can be adjusted together.
- If the volume of the TV speakers is different to the volume of the front speaker system or subwoofer system, adjust the volume of each amplifier to match that of the TV speakers.

TV buttons and parts

■ Front panel

<AV32L5EK and AV32L5EI>

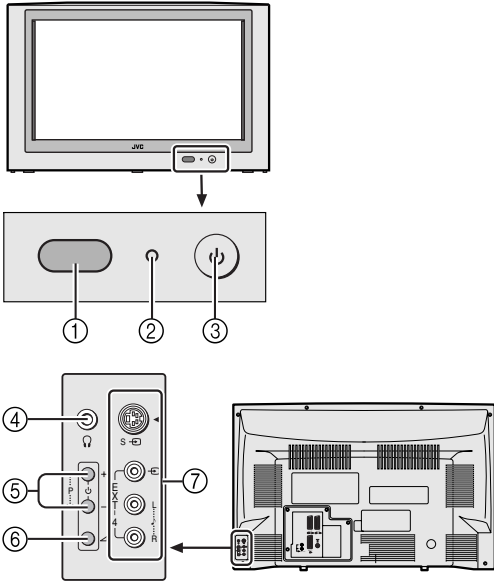

- ① Remote control sensor and ECO sensor
- ② Power lamp
- ③ Main power button
- ④ Headphone jack (mini jack)
- ⑤ P ∇/\blacktriangle buttons / -/+ buttons

<AV32P10EK and AV32P10EI>

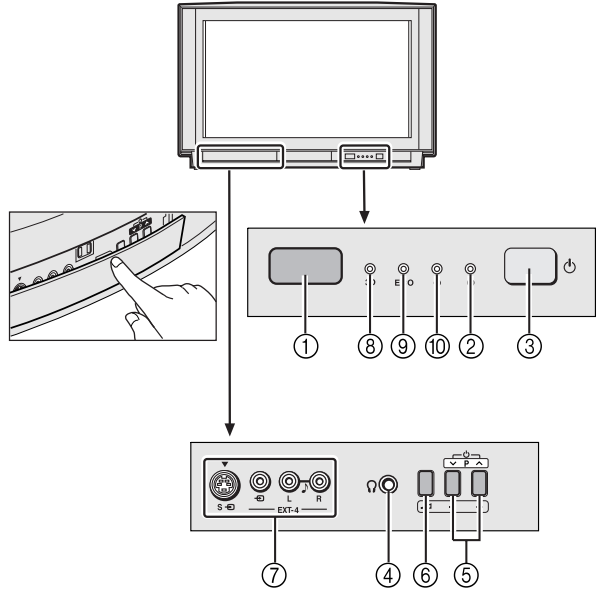

- ⑥ (Volume) button
- ⑦ EXT-4 terminal
- ⑧ 3D lamp (Only AV32P10EK and AV32P10EI)
 - The 3D lamp lights while the 3D-PHONIC function is in use.
- ⑨ ECO lamp (Only AV32P10EK and AV32P10EI)
 - If you set the ECO MODE function to ON, the ECO lamp lights.
- ⑩ SLEEP TIMER lamp (Only AV32P10EK and AV32P10EI)
 - The SLEEP TIMER lamp lights while the SLEEP TIMER function is operating.

■ Rear Panel

<AV32L5EK and AV32L5EI>

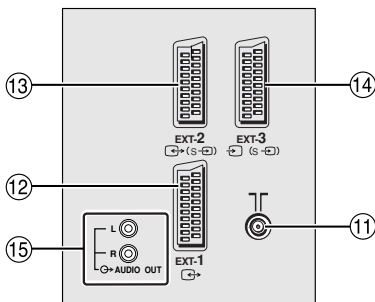

- ⑪ Aerial socket
- ⑫ EXT-1 terminal
- ⑬ EXT-2 terminal
- ⑭ EXT-3 terminal

<AV32P10EK and AV32P10EI>

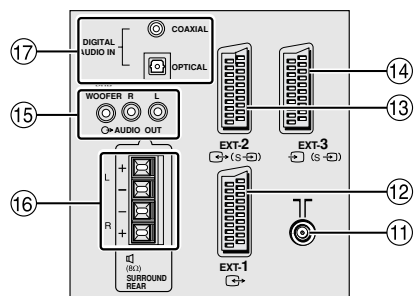

- ⑮ AUDIO OUT terminal
- ⑯ SURROUND REAR terminal (Only AV32P10EK and AV32P10EI)
- ⑰ DIGITAL AUDIO IN terminal (Only AV32P10EK and AV32P10EI)

Troubleshooting

If a problem arises while you are using the TV, please read this troubleshooting guide carefully before you ask to have the TV repaired. You may be able to fix it easily by yourself. For example, if the mains plug is disconnected from the mains outlet, or the TV aerial has problems, you may think there is a problem with the TV itself.

Important:

- This troubleshooting guide only covers problems whose causes are not easy to decide. If you have a question when you are operating a function, read the page(s) for that function carefully, not this troubleshooting guide.
- If you follow the advice in this troubleshooting guide without any success, unplug the mains plug and ask for your TV to be repaired. Do not attempt to repair the TV by yourself or to remove the rear cover of the TV.

If you cannot turn on the TV

- Is the mains plug connected to the mains outlet?
- Is the power lamp lit? If not, press the main power button.

No picture or no sound

- Have you chosen a TV channel with very poor reception? If so, the BLUE BACK function will be activated: the entire screen becomes blue, and the sound is muted. If you still want to view the TV channel, follow the description "BLUE BACK" on page 28 to try to change the BLUE BACK function setting to OFF.
- Have you set the speaker function to OFF? Follow the description "SPEAKER" on page 21 to check the speaker function setting.

Poor picture

- If noise (snow) totally blocks out the picture, there may be a problem with the aerial or aerial cable. Check the following to try to solve the problem:
 - Have the TV and aerial been connected properly?
 - Has the aerial cable been damaged?
 - Is the aerial pointing in the right direction?
 - Is the aerial itself faulty?
- If the TV or aerial suffers interference from other equipment, stripes or noise may appear in the picture. Move any equipment such as an amplifier, personal computer, or a hair drier, that can cause interference away from your TV. Or try moving the TV. If the aerial suffers interference from a radio tower or high-voltage wire, please contact your local dealer.
- If the TV suffers interference from signals reflecting from mountains or buildings, double-pictures (ghosting) will occur. Try to change the aerial's direction or replace it with one with better directionality.
- Are your COLOUR SYSTEM settings correct? Follow the description "COLOUR SYSTEM" on page 20 to try a way to solve the trouble.
- Have the COLOUR and BRIGHT settings been adjusted properly? Follow the description "Picture adjustment" on page 18 to try to adjust them properly.
- Videotaping teletext is not recommended because it may not record correctly.
- When a white and bright still image (such as a white dress) is displayed on the screen, the white part may look as if it is coloured. This is unavoidable due to the nature of the picture tube itself, and not due to a TV failure. When the picture disappears from the screen, the unnatural colours will also disappear.
- When viewing images from commercially available video software products, or videos from videotapes which have been recorded improperly, the top of the image may be distorted. This is due to the condition of the video signal, and not because of malfunction.

Poor sound

- Have you adjusted BASS or TREBLE properly? If not, follow the description "Sound adjustment" on page 21.
- When TV channel reception is poor, it can be hard to hear the stereo or bilingual sound. In this case, follow the description "STEREO / I/II" on page 21 to hear the sound more easily by changing it to a mono sound.

If the TV does not respond to the remote control.

- Have the batteries of the remote control worn out? Follow the description "Putting batteries into the remote control" on page 4 and replace them with new batteries.
- Have you attempted to use the remote control from the sides or rear of the TV or from more than seven metres away from the TV? Use the remote control in the front of your TV or from less than seven metres away.
- When you want to change the volume of the headphones, follow the description "HEADPHONE" on page 22.
- When you are viewing a teletext programme, you cannot operate the menus. Press the **TV** button to return to the ordinary TV programme, and then try operating the menus.
- If the TV will not respond suddenly, press the main power button on the TV and turn off the main power. Press the main power button again to turn on the TV. If the TV returns to a normal state, it is not a failure.

Other issues

- When the SLEEP TIMER function operates, the TV is automatically turned off. If the TV is turned off suddenly, try to press the $\odot/|$ (standby) button to turn on the TV once again. If the TV goes back to normal, there is no problem.
- When a wide screen signal (WSS) is included in the broadcast signal or the signal from an external device, or when the TV is receiving a control signal from an external device, the ZOOM mode will change automatically. When you want to return to the previous ZOOM mode, press the **ZOOM** button to choose the ZOOM mode again.
- If you bring a magnetised device such as a speaker near to your TV, the picture may be warped or unnatural colors may appear at the corners of the screen. In this case, keep the device from your TV. If speakers cause this to happen, use magnetic-shielded speakers instead.
- A picture may be tilted due to the earth's own magnetic field. If so, use the "PICTURE TILT" on page 20 to correct the tilt.
- It takes a short time from the time an operation such as changing channels is performed until an image is displayed. This is not a malfunction. This is the time it takes for the image to stabilize before it can be displayed.
- The TV may make a crackling sound due to a sudden change in temperature. The picture or sound may be normal. If you hear crackling sounds frequently while you are viewing the TV, there may be other causes. As a precaution, ask your service technician to inspect it.
- Touching the screen may cause you to feel a slight electric shock due to its static electricity. This is unavoidable due to the construction of the picture tube. It is not a problem with the TV. You can rest assured that this static discharge is not harmful.

Specifications

Model	AV32P10EK* (UK model)	AV32P10EI* (Ireland model)
Broadcasting systems	CCIR I	
Colour systems	PAL • The EXT terminals also support the NTSC 3.58/4.43 MHz system.	
Channels and frequencies	E21-E69	IR A-J, E2-E12, E21-E69, S1-S41, X, Y, Z, Z+1, Z+2, ITALY A-H, ITALY H+1, ITALY H+2
Sound-multiplex systems	NICAM (I) system	
Teletext systems	FLOF (Fastext), WST (World Standard Text)	
Power requirements	220 - 240 V AC, 50 Hz	
Power consumption	Maximum: 293 W, Average: 153 W, Standby: 2.8 W	
Picture tube size	Viewable area 76 cm (measured diagonally)	
Audio output	Rated Power output: 20 W + 20 W + 5 W	
Speakers	10 cm round × 2, 3.5 cm round × 2, (10 cm × 3 cm) oval × 1	
EXT-1 terminal	Euroconnector (21-pin, SCART) • Video input, Audio L/R inputs and RGB inputs are available. • TV broadcast outputs (Video and Audio L/R) are available.	
EXT-2 terminal	Euroconnector (21-pin, SCART) • Video input, S-VIDEO (Y/C) input, Audio L/R inputs and RGB inputs are available. • Video and Audio L/R outputs are available. • T-V LINK functions are available.	
EXT-3 terminal	Euroconnector (21-pin, SCART) • Video input, S-VIDEO (Y/C) input and Audio L/R inputs are available.	
EXT-4 terminal	RCA connectors × 3 S-VIDEO connector × 1 • Video input, S-VIDEO (Y/C) input and Audio L/R inputs are available.	
AUDIO OUT terminal	RCA connectors × 3 • Variable audio L/R outputs and subwoofer output are available. • Variable out 0-1 Vrms, low impedance	
SURROUND REAR terminal	Speaker terminals for external for surround speakers. • Surround rear sounds are output to the speakers. • For impedance 8-ohm speakers only. • Rated power output: 7.5 W + 7.5 W	
DIGITAL AUDIO IN terminal	Coaxial connector × 1 Optical connector × 1 • Dolby Digital is available.	
Headphone jack	Stereo mini-jack (3.5 mm in diameter)	
Dimensions (W × H × D)	855 mm × 550 mm × 568 mm	
Weight	57 kg	
Accessories	Remote control unit × 1 (RM-C57) AAA/R03 dry cell battery × 2	

* A basic model number. The actual model number may have characters added (such as "S" denoting silver) indicating the colour of the TV set.

We may change the design and specifications without notice.

Pictures displayed on the screen using this TV's ZOOM functions should not be shown for any commercial or demonstration purpose in public places (cafes, hotels, etc.) without the consent of the owners of copyright of the original picture sources, as this would be an infringement of copyright.